



QUICK START GUIDE

60 GHz cnWave™

System Release 1.2.2.1



Reservation of Rights

Cambium reserves the right to make changes to any products described herein to improve reliability, function, or design, and reserves the right to revise this document and to make changes from time to time in content hereof with no obligation to notify any person of revisions or changes. Cambium recommends reviewing the Cambium Networks website for the latest changes and updates to products. Cambium does not assume any liability arising out of the application or use of any product, software, or circuit described herein; neither does it convey license under its patent rights or the rights of others. It is possible that this publication may contain references to, or information about Cambium products (machines and programs), programming, or services that are not announced in your country. Such references or information must not be construed to mean that Cambium intends to announce such Cambium products, programming, or services in your country.

Copyrights

This document, Cambium products, and 3rd Party software products described in this document may include or describe copyrighted Cambium and other 3rd Party supplied computer programs stored in semiconductor memories or other media. Laws in the United States and other countries preserve for Cambium, its licensors, and other 3rd Party supplied software certain exclusive rights for copyrighted material, including the exclusive right to copy, reproduce in any form, distribute and make derivative works of the copyrighted material. Accordingly, any copyrighted material of Cambium, its licensors, or the 3rd Party software supplied material contained in the Cambium products described in this document may not be copied, reproduced, reverse engineered, distributed, merged or modified in any manner without the express written permission of Cambium. Furthermore, the purchase of Cambium products shall not be deemed to grant either directly or by implication, estoppel, or otherwise, any license under the copyrights, patents or patent applications of Cambium or other 3rd Party supplied software, except for the normal non-exclusive, royalty free license to use that arises by operation of law in the sale of a product.

Restrictions

Software and documentation are copyrighted materials. Making unauthorized copies is prohibited by law. No part of the software or documentation may be reproduced, transmitted, transcribed, stored in a retrieval system, or translated into any language or computer language, in any form or by any means, without prior written permission of Cambium.

License Agreements

The software described in this document is the property of Cambium and its licensors. It is furnished by express license agreement only and may be used only in accordance with the terms of such an agreement.

High Risk Materials

Cambium and its supplier(s) specifically disclaim any express or implied warranty of fitness for any high-risk activities or uses of its products including, but not limited to, the operation of nuclear facilities, aircraft navigation or aircraft communication systems, air traffic control, life support, or weapons systems ("High Risk Use").

This product is not restricted in the EU. Any High Risk is unauthorized, is made at your own risk and you shall be responsible for any and all losses, damage or claims arising out of any High-Risk Use.

Contents

- Contents** **3**
- Introduction** **5**
- Product Description** **6**
- Installation and Operation** **7**
- Product Safety Information** **8**
- Hardware Overview** **10**
 - V1000 10
 - V1000 Wall and pole mount 10
 - V2000 11
 - V2000 Adjustable pole mount 12
 - V3000 14
 - V3000 Precision bracket (C000000L125A) 14
 - V3000 Tilt bracket (N000045L002A) 16
 - V5000 18
 - V5000 Pole mount (C000000L137A) 18
 - Mounting of 60 GHz cnWave™ products 19
 - V1000 Pole mount 19
 - V1000 Wall mount 20
 - V2000 Adjustable pole mount 22
 - V3000 Precision bracket 25
 - V5000 Pole mount bracket 33
- Connecting 60 GHz cnWave Products** **37**
 - Installing PSU and powering the ODU 37
 - Installing the 60W DC power injector 38
 - Installing the AC/DC PSU 40
 - Installing 15W or 30W power injector 41
- Operation** **43**

Configuration and Alignment	44
Deployment of nodes	44
Antenna alignment	45
Bridge-in-a-Box - Getting Started	52
Bridge-in-a-Box solutions	52
Package contents	53
Features	54
Benefits and use cases	54
Hardware installation	55
Configuration	55
Support contacts	55
Glossary	56
Cambium Networks	57

Introduction

This Quick Start Guide assists operators in acquiring a high-level understanding of the 60 GHz cnWave™ platform hardware, installation methods, initial login procedures, and safety/warranty information.

Product Description

The 60 GHz cnWave™ solution from Cambium Networks provides easy, fast, and cost-effective wireless Gigabit connectivity for edge access and/or high-capacity backhaul for edge access solutions at a significantly lower than fiber infrastructure. Service providers and enterprises now have access to Gigabit for business and residential connectivity, backhaul for Wi-Fi access. Certified for Facebook Terragraph, 60 GHz cnWave™ mesh solutions are highly efficient at handling high-density deployments in cities and suburban areas.

Figure 1: 60 GHz cnWave™ products



Installation and Operation

Installation and operation of this product are complex, and Cambium, therefore, recommends professional installation and management of the system to ensure that operation complies with the regulations of the region where the product is installed. Follow the instructions described in this *Quick Start Guide*. For more details on the installation and operation of 60 GHz cnWave devices, refer *60 GHz cnWave™ User Guide*.

The installer must have sufficient skills, knowledge and experience to perform the installation task and is responsible for:

- Familiarity with current applicable national regulations including radio regulations, electrical installation regulations, surge protection regulations and 'working at heights' regulations
- Installation following Cambium Networks instructions
- Confirming that the equipment settings are compliant with national or regional regulations
- Familiarity with training material available on the Cambium Networks website.

Observe the important instructions given in this guide during installation. This sets the equipment in compliance with national regulatory regulations and ensures legal operation.

Ensure the 60 GHz cnWave equipment is fitted with the latest application code. The software is available on the Cambium Networks [Support](#) site. For contact details, visit the [Contact Support](#) site.

Product Safety Information



Warning

To prevent loss of life or physical injury, observe the following safety guidelines. In no event shall Cambium Networks be liable for any injury or damage caused during the installation of the Cambium 60 GHz cnWave radio nodes. Ensure that only qualified personnel install 60 GHz cnWave radios.



Attention

Pour éviter toute perte de vie ou blessure physique, respectez les consignes de sécurité suivantes. En aucun cas Cambium Networks ne pourra être tenu responsable des blessures ou dommages causés lors de l'installation des nœuds radio Cambium 60 GHz cnWave. Assurez-vous que seul du personnel qualifié installe les radios cnWave 60 GHz.

1. Exercise extreme care when working near power lines.
2. Exercise extreme care when working at heights.
3. Always use one of the approved power supply options. Failure to use the Cambium-supplied PSUs could result in equipment damage and will invalidate the safety certification and may cause a safety hazard.
4. The cnWave™ radios must be properly grounded to protect against lightning. It is the user's responsibility to install the equipment in accordance with national regulations. In the USA, follow the requirements of the National Electrical Code NFPA 70-2005 and 780-2004 Installation of Lightning Protection Systems. In Canada, follow Section 54 of the Canadian Electrical Code. These codes describe correct installation procedures for grounding the outdoor unit, mast, lead-in wire and discharge unit, size of grounding conductors and connection requirements for grounding electrodes. Other regulations may apply in different countries and therefore it is recommended that installation of the outdoor unit be contracted to a professional installer.
5. Always use an appropriately rated and approved AC supply cord-set in accordance with the regulations of the country of use.
6. Before servicing 60 GHz cnWave equipment, always switch off the power supply and unplug it from the PSU. Do not disconnect the RJ45 drop cable connectors from the radio while the PSU is connected to the power supply. Always remove the AC or DC input power from the PSU.
7. The main power supply is the primary disconnect device.
8. Safety may be compromised if outdoor-rated cables are not used for connections that will be exposed to the outdoor environment.
9. The PSU output voltage may be hazardous in some conditions, for example in wet weather. Do not connect a drop cable tester to the PSU, either directly or via LPUs.

10. Strong radio frequency (RF) fields will be present close to the antenna when the transmitter is on. Always turn off the power to the radio before undertaking maintenance activities in front of the antenna.
11. Ensure that personnel is not exposed to unsafe levels of RF energy. The units start to radiate RF energy as soon as they are powered up. Never work in front of the antenna when the radio is powered. Install the radios to provide and maintain the minimum separation distances from all persons. For minimum separation distances, refer *60 GHz cnWave™ User Guide*.
12. Ensure that the installation meets the requirements defined in the [Installation](#) section.
13. To provide effective protection against lightning-induced surges, observe these requirements:
 - Grounding conductor runs are as short, straight and smooth as possible, with bends and curves kept to a minimum.
 - Grounding cables must not be installed with drip loops.
 - All bends must have a minimum radius of 200 mm (8 in) and a minimum angle of 90°. A diagonal run is preferable to a bend, even though it does not follow the contour or run parallel to the supporting structure.
 - All bends, curves, and connections must be routed towards the grounding electrode system, ground rod, or ground bar.
 - Grounding conductors must be securely fastened.
 - Braided grounding conductors must not be used.
 - Approved bonding techniques must be used for the connection of dissimilar metals.
14. Radios are not designed to survive direct lightning strikes. For this reason they must be installed in Zone B as defined in the **Lightning protection zones** section in the *60 GHz cnWave™ User Guide*. Mounting in Zone A may put equipment, structures, and life at risk.

Hardware Overview

The 60 GHz cnWave solution includes four types of wireless nodes:

- V1000 Client Node (CN)
- V2000 Client Node (CN)
- V3000 Client Node (available in two antenna sizes - 40.5 dBi or 44.5 dBi)
- V5000 Distribution Node (DN)

V1000

A **Client Node (CN)** that contains a wide-range, 80 degrees beamforming for easy installation. This CN is powered by 802.3af PoE and supports up to 2 Gbps for PTP and PMP configurations.

Figure 2: V1000 CN



V1000 Wall and pole mount

The V1000 CN is supplied with a mounting plate and band clamp. The mounting plate can be used for mounting the V1000 on a wall, or it can be used with the supplied band clamp to mount the V1000 on a pole with a diameter in the range of 25 mm to 70 mm (1 inch to 2.75 inches). Note that the larger diameters can be accommodated with the customer supplied clamps.

Figure 3: V1000 Mounting plate and band clamp



V1000 Adjustable pole mount (N000900L022A)

The adjustable pole mount is used to provide elevation adjustment when a V1000 CN is mounted on a pole. The adjustable pole mount works with poles with a diameter in the range of 25 mm to 70 mm (1 inch to 2.75 inches).



Note

The adjustable pole mount does not come with a clamp. You can use the one that is supplied with the V1000 box. Larger diameter poles can be accommodated with the customer-supplied clamps.

Figure 4: V1000 Adjustable pole mount

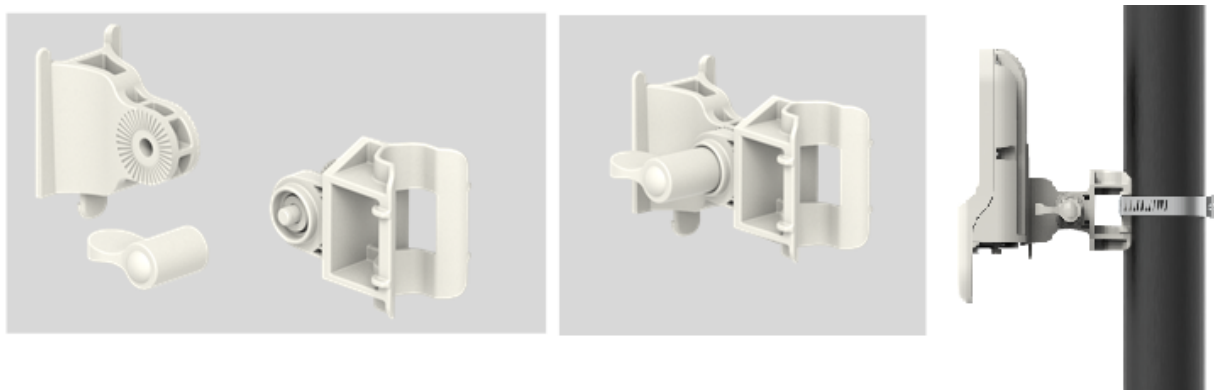

V2000

The V2000 CN contains a 34.5 dBi antenna with beamforming. This client node can support up to 3.6 Gbps for PTP and PMP configurations.

It can support a single wireless link and therefore, it can be used as a CN in all topologies or POP in a PTP topology.

Figure 5: V2000 CN's front and rear views



This outdoor CN can be connected to a DN. It can also act as a DN for PTP deployments. It supports a 2.5 Gigabit Ethernet Main interface and 2.5 Gigabit Ethernet Aux interface.

For more information about the V2000 CN features, Aux PoE interface, and installation, refer to the *60 GHz cnWave™ User Guide*.

V2000 Adjustable pole mount

The V2000 CN is supplied with adjustable pole mounting accessories such as mounting plate, a jubilee clip (hose clamp), and four screws (as shown in [Figure 6](#)). These mounting accessories can be used to mount the V2000 CN on a vertical pole.

Figure 6: V2000 Pole mounting accessories

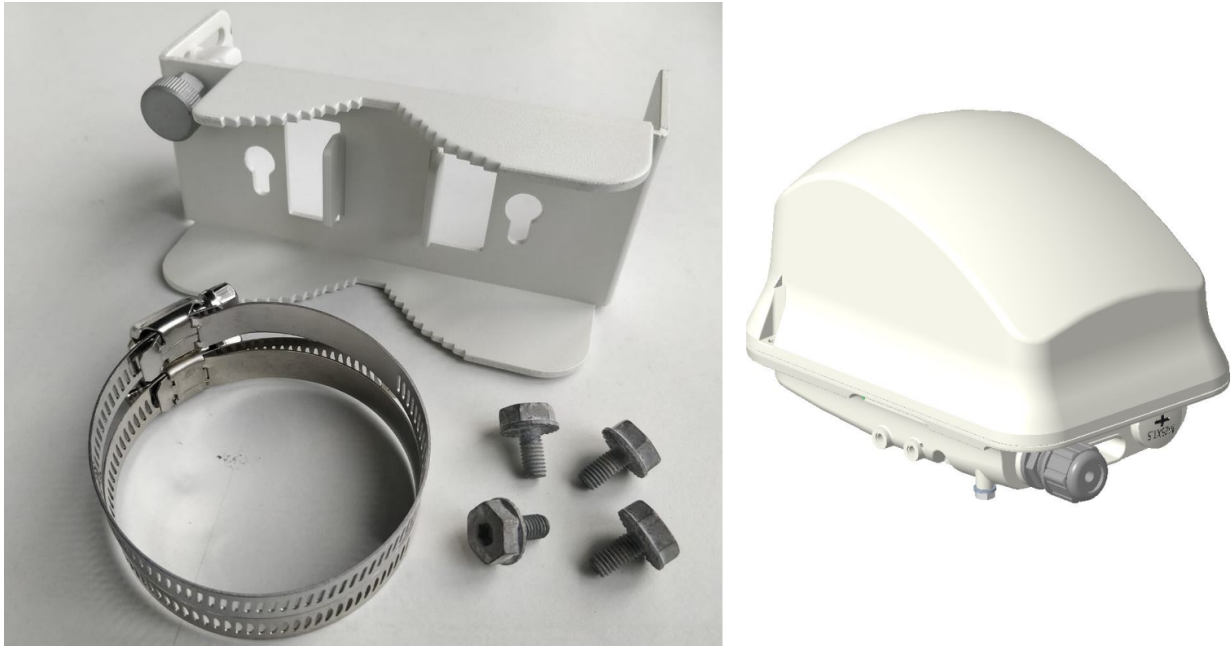

The adjustable pole mount bracket (as shown in Figure 7) is used to mount the V2000 CN on a vertical pole with a diameter in the range of 25 mm to 70 mm (1 inch to 2.75 inches). The bracket provides a fine adjustment of up to $\pm 20^\circ$ in elevation for accurate alignment of V2000.

Figure 7: V2000 Adjustable pole mount



V3000

A **Client Node (CN)** that is available in two sizes - 44.5 dBi high-gain antenna and 40.5 dBi lower gain antenna, both with beamforming. These client nodes can support up to 5.4 Gbps, with channel bonding, for PTP configurations.

Figure 8: V3000 Client Node with CN antenna (in two antenna sizes 40.5 dBi or 44.5 dBi)



V3000 Precision bracket (C000000L125A)

The precision bracket (as shown in [Figure 9](#)) is used to mount the V3000 CN on a vertical pole with a diameter in the range of 25 mm to 70 mm (1 inch to 2.75 inches). It accepts band clamps for larger diameter poles. The precision bracket provides fine adjustment of up to 18° in azimuth and +/-30° in elevation for accurate alignment of the V3000.

Figure 9: V3000 Precision bracket

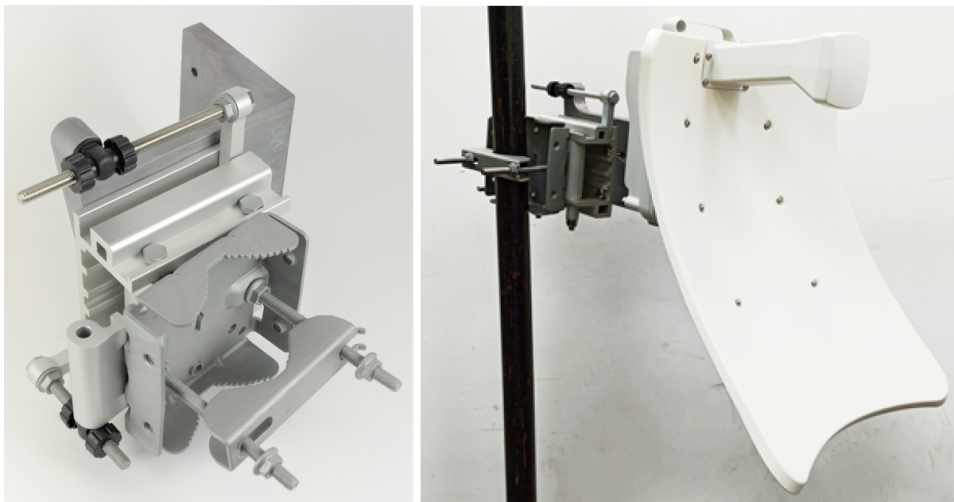

V3000 precision bracket components

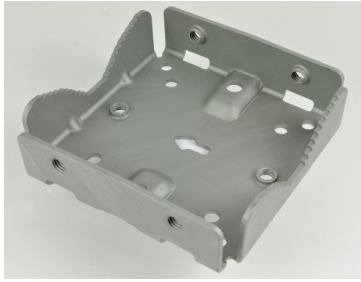

Bracket body



Azimuth arm



Long (120 mm) M8 screws and flange nuts

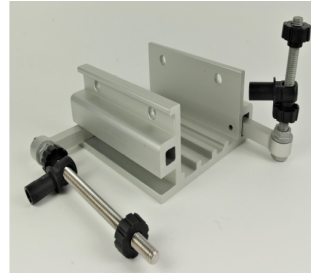

Bracket base



40 mm M8 screws, plain washers and Nyloc nuts

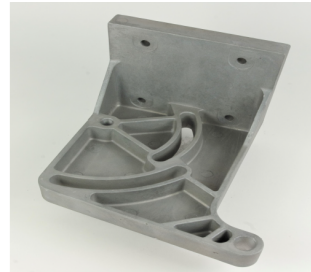

V3000 mount



28 mm M6 screws, M8 spacers and pole mount clamp

V3000 Tilt bracket (N000045L002A)

The tilt bracket (as shown in [Figure 10](#)) is used to provide elevation adjustment when a V3000 CN or V5000 DN is mounted on a pole. The tilt bracket works with poles with diameter in the range of 25 mm to 70 mm (1 inch to 2.75 inches).

The tilt bracket assembly may be used with third-party band clamps to mount the ODU on a larger pole (the diameter range depends on the clamps used).

[Figure 10](#): Tilt bracket assembly



Radio alignment tools for V3000

You can use the following radio accessories for aligning the V3000 radio during the installation:

- **Telescope mount kit**

The Precision bracket and an alignment telescope provide the most accurate option for aligning the radio during installation. The telescope is temporarily mounted on the bracket using the telescope mounting kit for precision brackets.

The telescope mounting kit consists of a mounting plate, a knurled screw, and two rubber O-rings. Order the telescope mounting kit from Cambium Networks.

[Figure 11](#): Telescope mounting kit

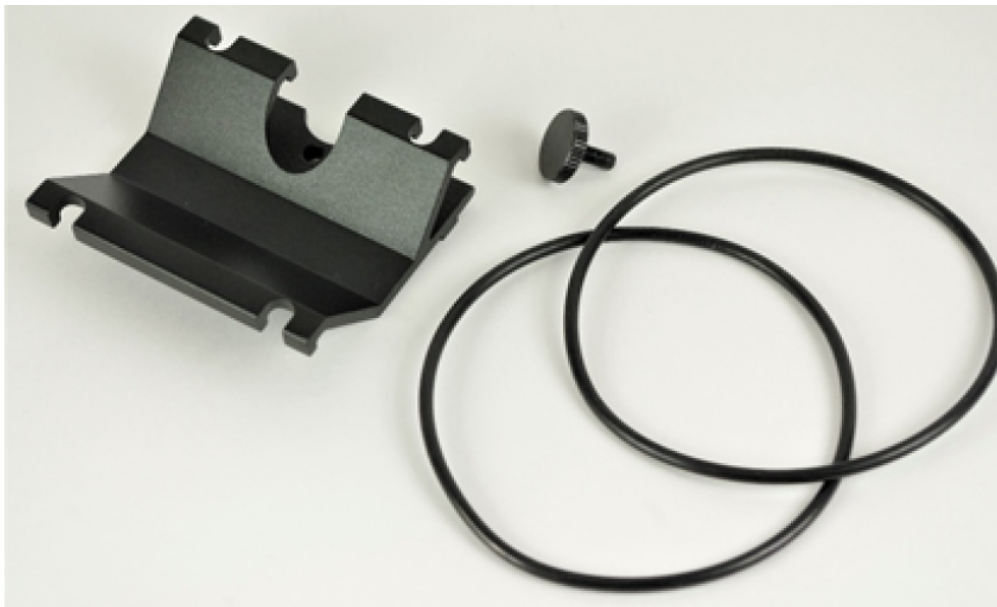

Order a suitable telescope from a specialist supplier specifying the following details:
 Right angle, erecting, 9x50 mm alignment scope with 5° field of view

Figure 12: Typical alignment telescope

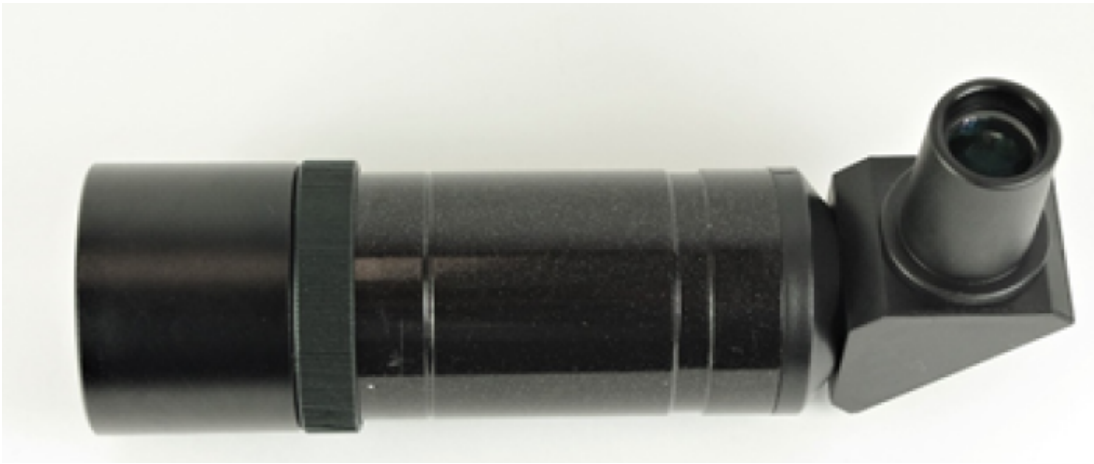

- **Alignment tube**

The Alignment tube (as shown in Figure 13) is designed to be used with V3000 when setting up a Point-to-Point link. It is Ideal for aligning a Point-to-Point link that spans up to 600 m.

Figure 13: Alignment Tube



For longer links up to 3 km, Cambium Networks suggests to use the telescopic mounting kit (C000000L139) and a finder scope.

Order the following radio accessories from Cambium Networks using the part Numbers.

Table 1: Radio accessory part numbers

Accessory	Radio nodes	Cambium Part Number
Telescope mounting kit	V3000	C000000L139A
Alignment Tube	V3000	C000000L190A

For more information on fixing these alignment tools for V3000, refer to the *60 GHz cnWave™ User Guide*.

V5000

A **dual-sector Destination Node (DN)** that contains two sectors covering up to 280 degrees with beamforming. A single V5000 can connect up to four other distribution nodes or up to 30 client nodes. V5000 can be used for PTP, PMP, and Mesh configurations.

Figure 14: V5000 DN

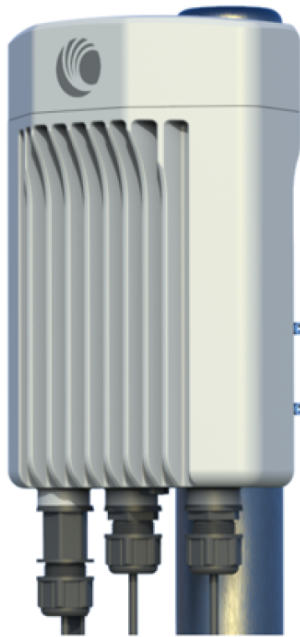

V5000 Pole mount (C000000L137A)

The Pole Mount (as shown in Figure 15) is used to mount a V5000 DN on a vertical pole with diameter in the range 25 mm to 70 mm (1 inch to 2.75 inches). It provides coarse azimuth (but not elevation) adjustment. Band clamps can be used for V5000 pole mount to accommodate the larger diameter poles.

Figure 15: V5000 Pole mount



V5000 Wall mount (C000000L136A)

The Wall Mount (as shown in [Figure 16](#)) is used to mount a V5000 DN on a vertical wall. It does not provide azimuth or elevation adjustment. The wall mount requires additional fixing hardware suitable for the type of wall.

Figure 16: V5000 Wall mount

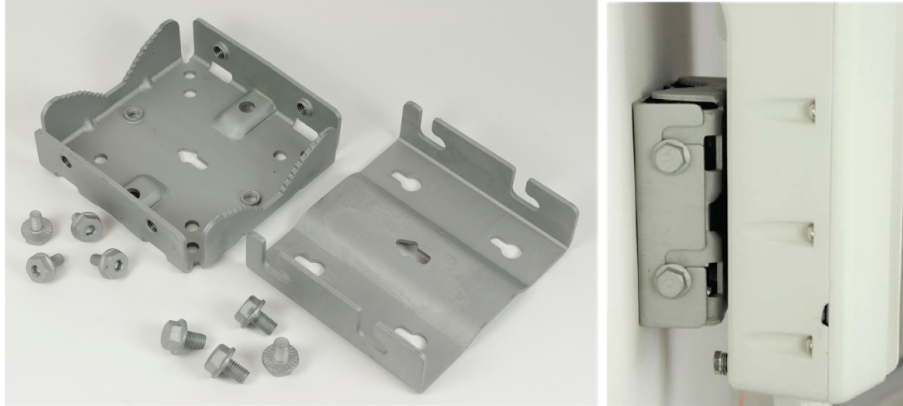

Mounting of 60 GHz cnWave™ products

V1000 Pole mount

The V1000 CN can be installed to a pole using the supplied mounting plate and jubilee clip. Follow the below instructions to mount V1000 to the pole:

1. Insert the hose clamps through mounting plate and clamp to the pole by applying 3.0 Nm torque.

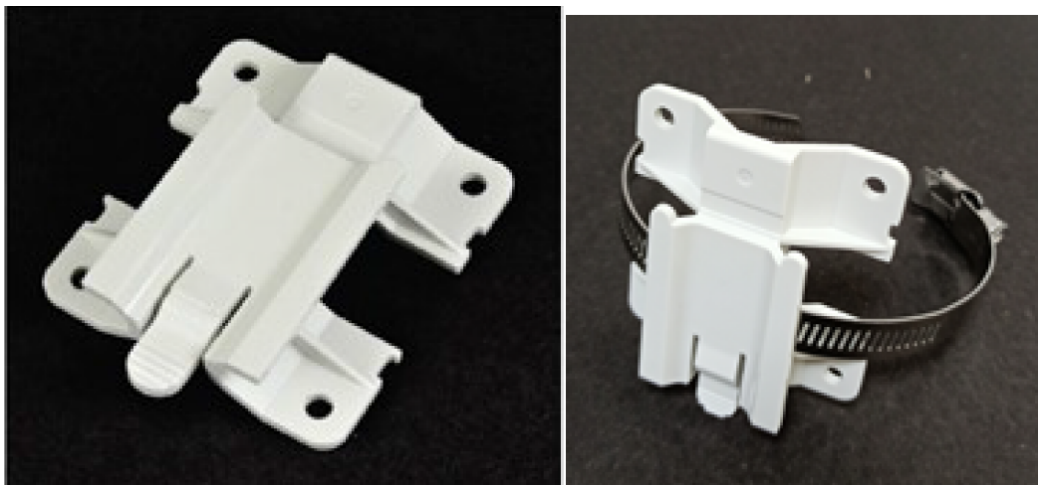

2. Insert the radio into the mounting plate on the pole.



V1000 Wall mount

Follow the below instructions to mount V1000 to the wall:

1. Fix the mounting plate (supplied with the V1000 ODU) securely to a vertical wall, using suitable fixings.



Note

Fixing hardware is not supplied with the V1000.

2. Slide the V1000 ODU onto the mounting plate from above, ensuring that the spring clip in the

mounting plate clicks into place on the radio.

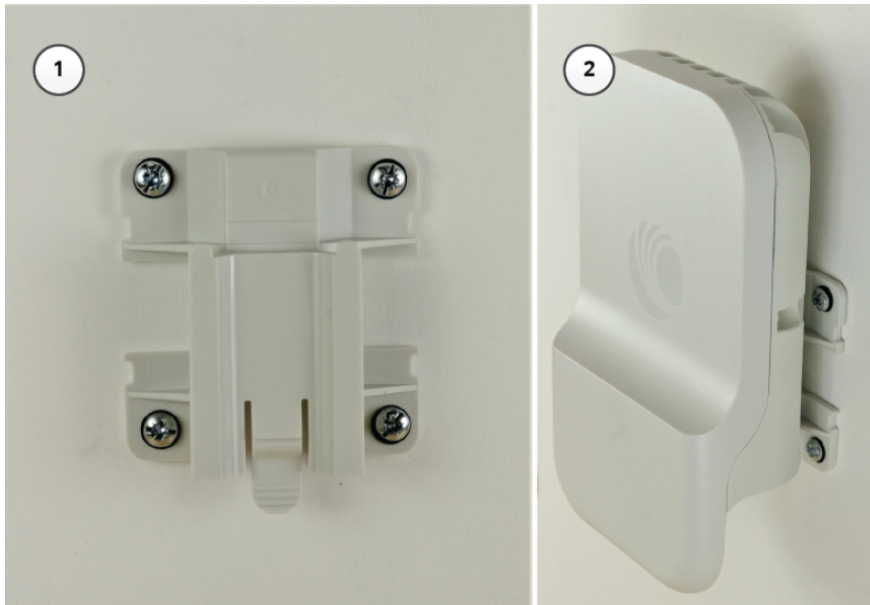

Adjustable pole mount

Follow the below instructions to mount V1000 to the adjustable pole:

1. Insert the hose clamps through the adjustable pole mount bracket and clamp to the pole by applying 3.0 Nm torque.

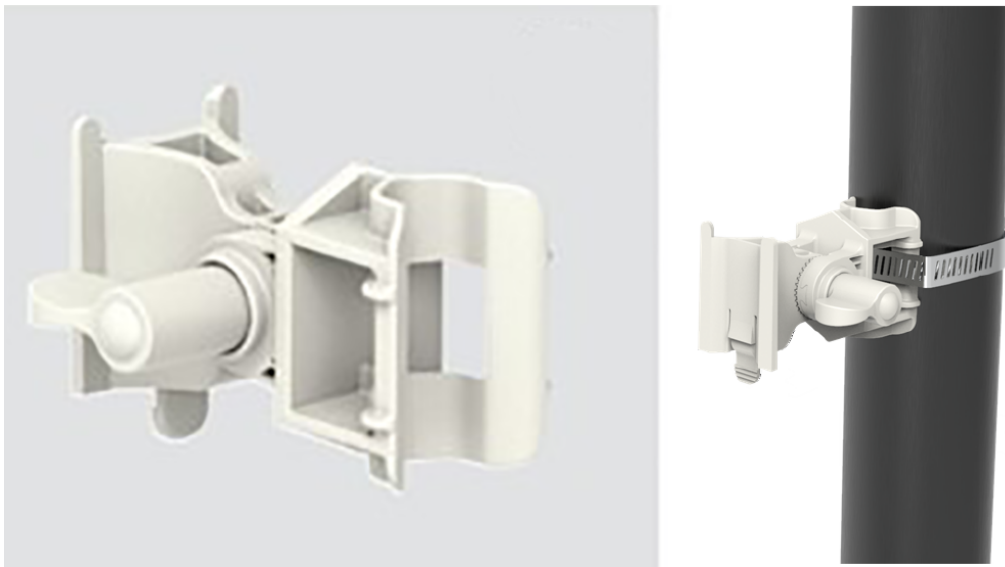

2. Insert the radio into the adjustable pole mount bracket on the pole.



The adjustment can be made up to maximum +/- 30 degrees and each serration movement is 5 degrees.

V1000 Alignment

The V1000 CN requires minimal effort to align as the internal antenna can beam steer +/- 40 degrees in azimuth and +/- 20 degrees in elevation from boresight. As long as the unit is installed with the remote node visible within this range, no further adjustment is required.

V2000 Adjustable pole mount

You can install the V2000 CN on a pole using a jubilee clip (hose clamps). Perform the following steps to mount the V2000 CN on a pole:

1. Insert the two hose clamps through the adjustable mounting bracket and clamp it to the pole by applying 3.0 Nm torque.



2. Align the device by viewing through the eye piece and the notch on radome.

Figure 17: Aligning the V2000 device

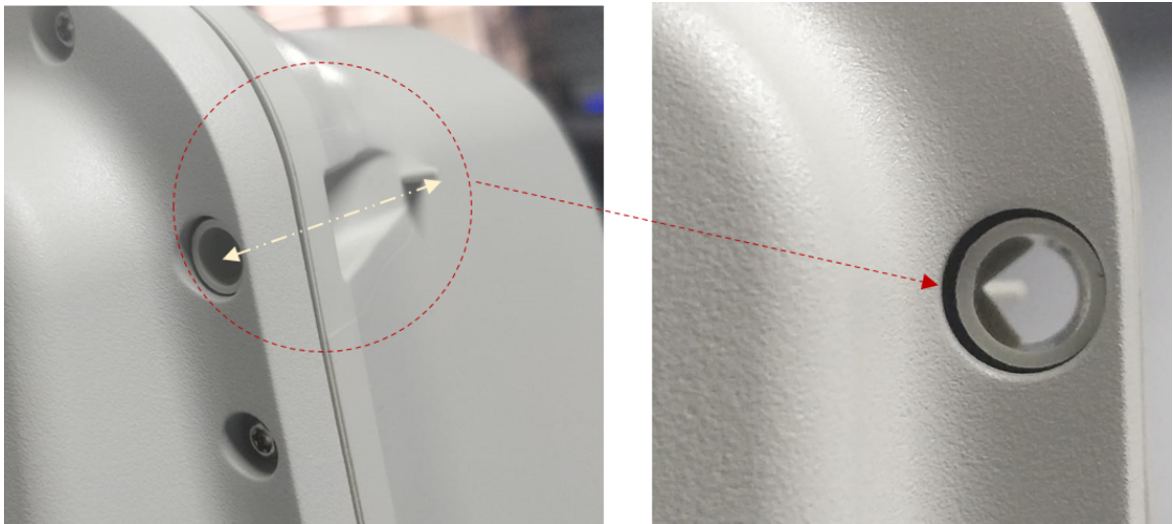

3. Use the bracket knob to rotate fine adjustable bracket until the alignment is complete in the elevation plane

The adjustable bracket supports the fine adjustment of up to $\pm 20^\circ$ in elevation for an accurate alignment of the V2000 device.

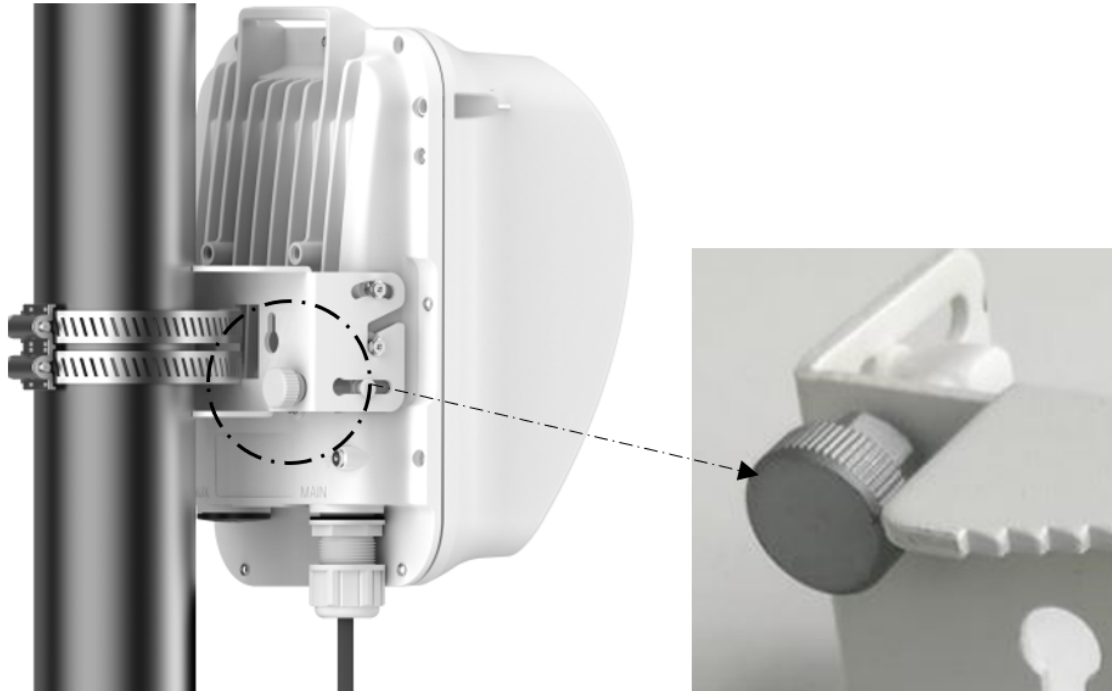

V2000 Alignment

The V2000 CN requires minimal effort to align as the internal antenna can beam steer ± 10 degrees in azimuth and ± 4.5 degrees in elevation from boresight. If the unit is installed with the remote node visible within this range, no further adjustment is required.

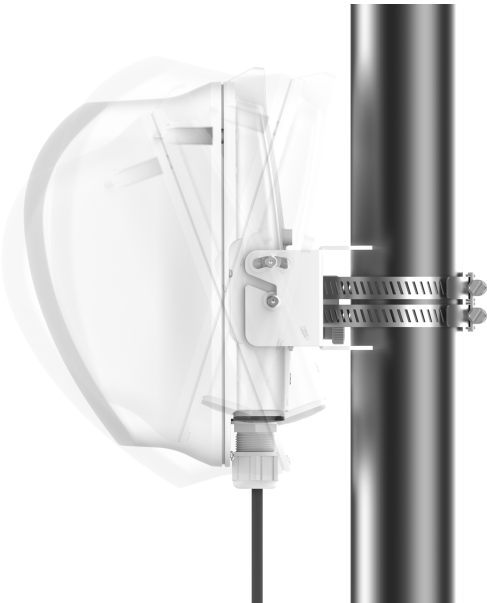

V3000 Precision bracket

The precision bracket is used to mount the cnWave V3000 CN on a vertical pole, providing fine adjustment up to 18° in azimuth and $\pm 30^\circ$ in elevation for accurate alignment of the V3000. The precision bracket is compatible with pole diameters in the range of 25 mm to 70 mm (1 inch to 2.75 inches). Note that the Jubilee clamp allows for larger diameter poles and the range depends on the clamps used.

These instructions illustrate the procedure for assembling and using the precision bracket. We also illustrate the mounting of the optional alignment telescope.

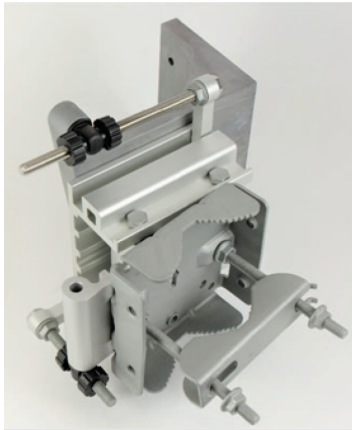

1. Insert two of the long (120 mm) screws through the azimuth arm and the bracket body. The screws are located in the slots in the azimuth arm.

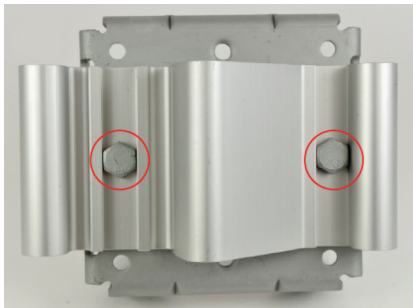

2. Fit two flanged M8 nuts to the long screws on the back of the bracket. Tighten using a 13 mm spanner.

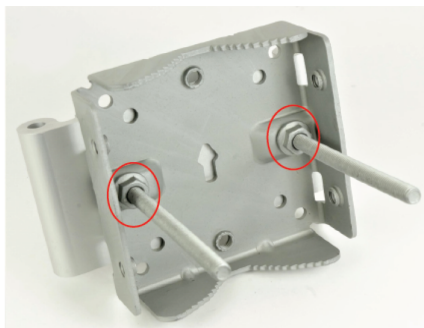

3. Insert the three medium-length (40 mm) M8 screws through the bracket base and the V3000 mount. The screws are located in the slots in the bracket base.

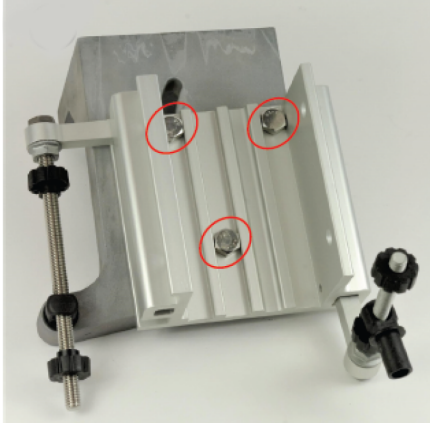

4. Ensure that the pivot pin in the elevation adjuster is located in the circular hole in the V3000 mount.

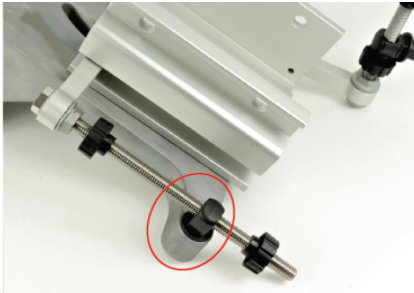

5. Fit plain washers and M8 Nyloc nuts to the screws on the back of the bracket base. Tighten using a 13 mm spanner.

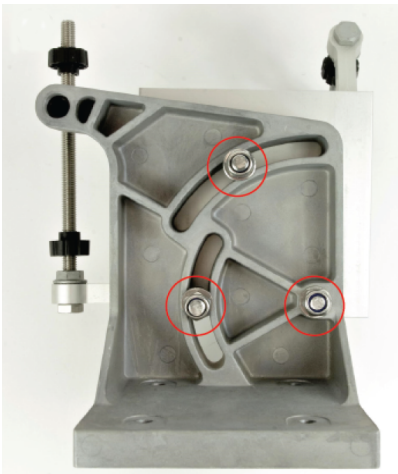

6. Insert the two remaining long (120 mm) M8 screws through the bracket body and the azimuth arm. The screws are located in the slots in the bracket body.

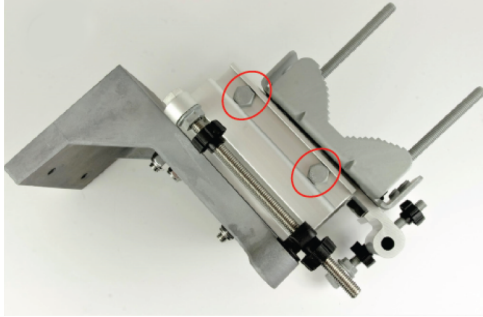

7. Ensure that the pivot pin in the azimuth adjuster is located in the circular hole in the bracket body.

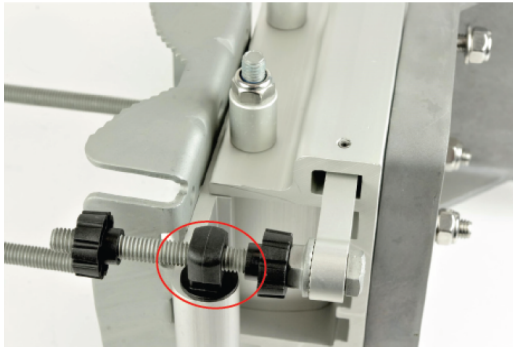

8. Fit three sets of spacers, plain washers and M8 Nyloc nuts to the screws on the underside of the bracket base. Tighten using a 13 mm spanner.

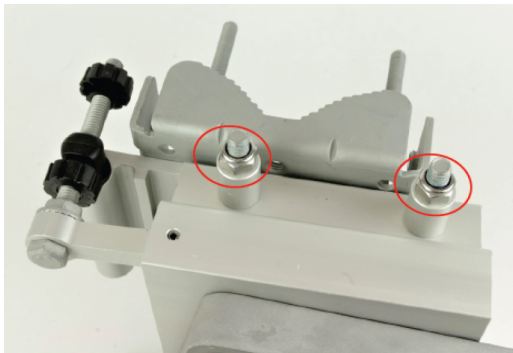

9. Attach the V3000 mount to the radio using the four short M6 bolts. Tighten the four bolts to a torque setting of 5.0 Nm (3.7 lb-ft) using a 13 mm spanner or socket.

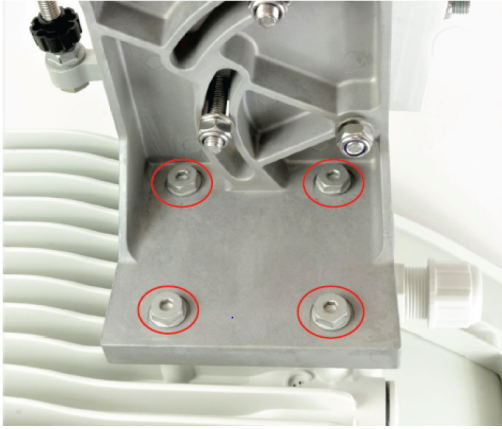

10. Attach the precision bracket to the pole using the clamp and the remaining flanged nuts. Adjust azimuth approximately and tighten the nuts to 10 Nm (7.4 lbft) using a 13 mm spanner.

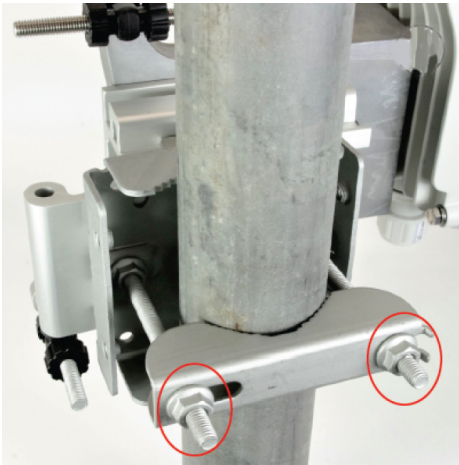

11. Lock the antenna alignment by tightening the five Nyloc nuts (see [step 5](#) and [step 8](#)) to 10 Nm (7.4 lbft) using a 13 mm spanner or socket.

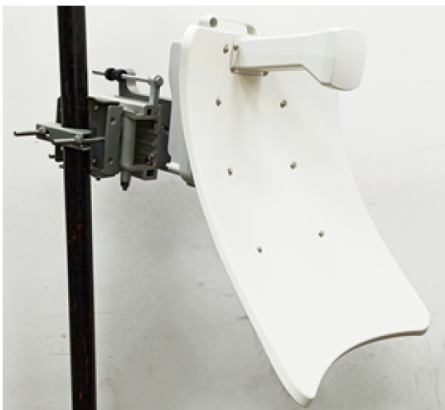

Note

Visit the [Cambium Learning website](#) to learn more about the precision bracket assembly.

Precision bracket alignment using telescope

Follow the below instructions to align the telescope:

1. Attach the telescope mount to the V3000 radio using the knurled screw.
2. Attach the telescope by looping the two elastic O-rings over the ears of the mount. Ensure that the telescope is located securely while mounting.



Precision bracket alignment

1. Ensure that the three Nyloc screws for securing the bracket in elevation are loose and the fine elevation adjuster is holding the weight of the unit.

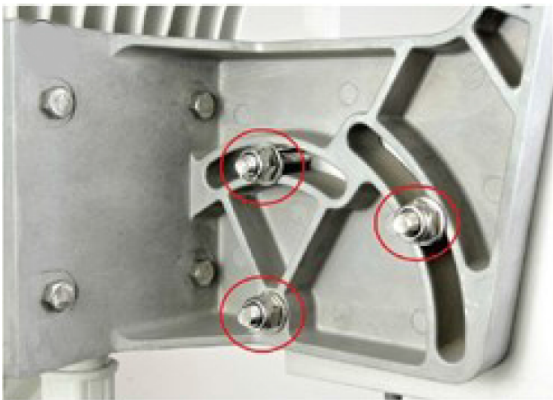

2. Ensure that the two Nyloc screws for securing the bracket in the azimuth are loose.



3. Before starting the mechanical alignment, move the fine elevation adjuster 2/3 of the way across the screw until the unit is sitting at approximately 0 degrees in elevation.

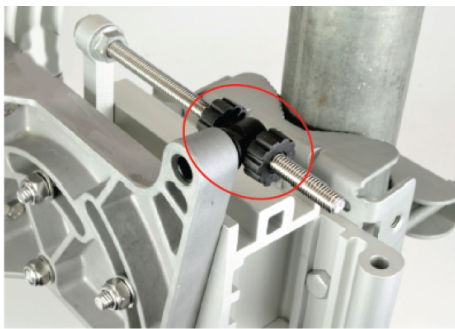

4. Move the fine azimuth adjuster to approximately the center of the available range and lock it in position.



5. Loosen the clamp which attaches the bracket to the pole until there is enough freedom to rotate the unit in azimuth.
6. From behind the unit, using the sight to aim towards the remote node, rotate the unit until it is approximately aligned in azimuth. Tighten the clamp.

7. While looking for the far node through the site, rotate the fine elevation adjuster until the alignment is complete in the elevation plane. One turn of the adjustment wheel is equivalent to approximately one degree of elevation. Lock the fine elevation adjuster screws in place.

You can use the alignment tube, as shown below:

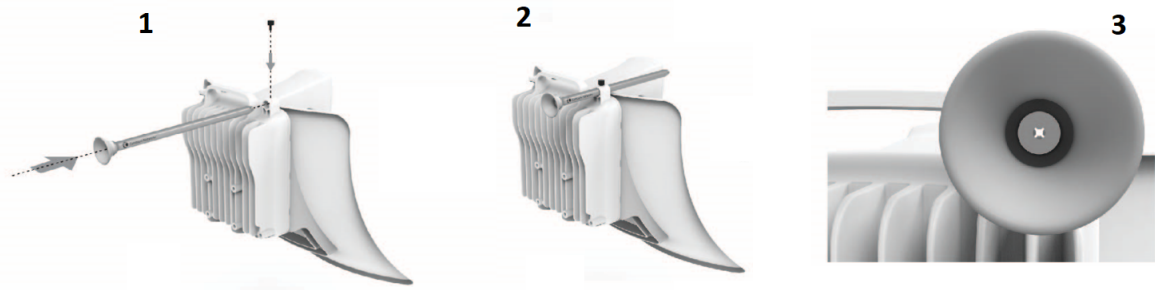

For more details on how to use the alignment tube, refer to the *60 GHz cnWave™ User Guide*.

8. While looking for the far node through the site, rotate the fine azimuth adjuster until the alignment is complete in the azimuth plane. One turn of the adjustment wheel is equivalent to approximately one degree of azimuth. Lock the fine azimuth adjuster screws in place.
9. Make any remaining adjustments to the elevation and azimuth as required. Once complete, tighten the three Nyloc screws in place to fix the elevation alignment and do the same for the two Nyloc screws for azimuth alignment to 10 Nm (7.4 lbft) using a 13 mm spanner or socket.

V3000 Tilt bracket assembly

1. Fix the mounting plate of the tilt bracket to the back of the radio using four of the short bolts, ensuring that the arrow in the plate points towards the top of the radio. Tighten the four bolts to a torque setting of 5.0 Nm (3.7 lb-ft) using a 13 mm spanner or socket.

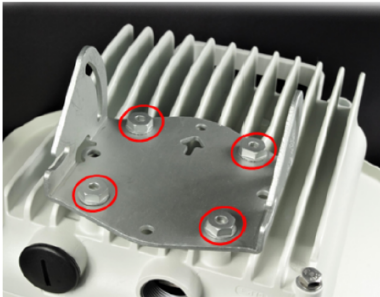

2. Fit the two long bolts through the bracket body so that the bolt heads engage in the slots as shown. Fit two of the short bolts into the side of the bracket body but do not tighten.

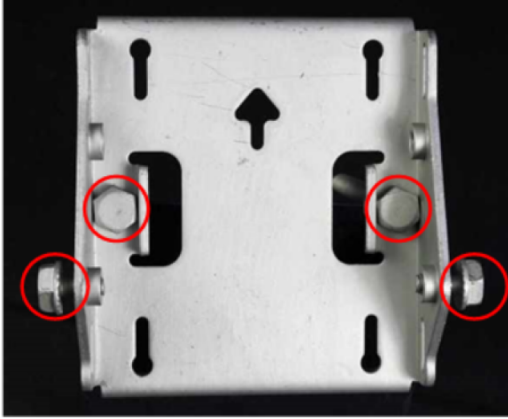

3. Thread two of the nuts to the long bolts and tighten against the bracket body using a 13 mm spanner. Fit the bracket strap and thread the remaining nuts onto the long bolts.

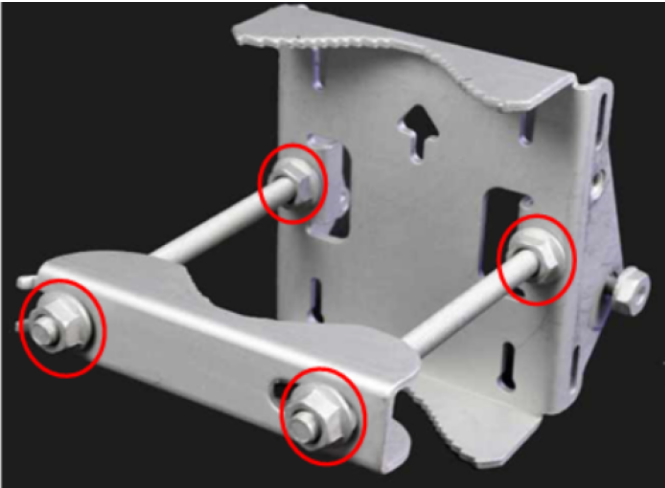

4. Fix the assembled bracket body to the pole, adjust the azimuth angle, and tighten the nuts to a torque setting of 10.0 Nm (7.4 lb-ft) using a 13 mm spanner, ensuring that the arrow in the body is pointing upwards.

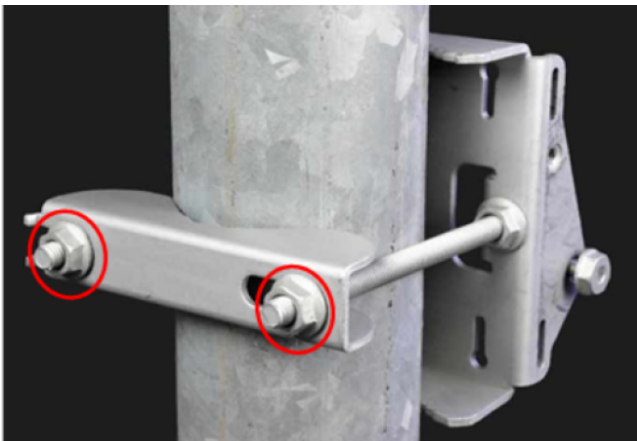

5. Fit the mounting plate to the bracket body by positioning the open- ended slots over the short bolts. Insert the remaining short bolts through the longer curved slots into the threaded holes in the bracket body. Adjust the elevation angle and tighten the bolts to a torque setting of 5.0 Nm (3.7 lb-ft) using a 13 mm spanner or socket.

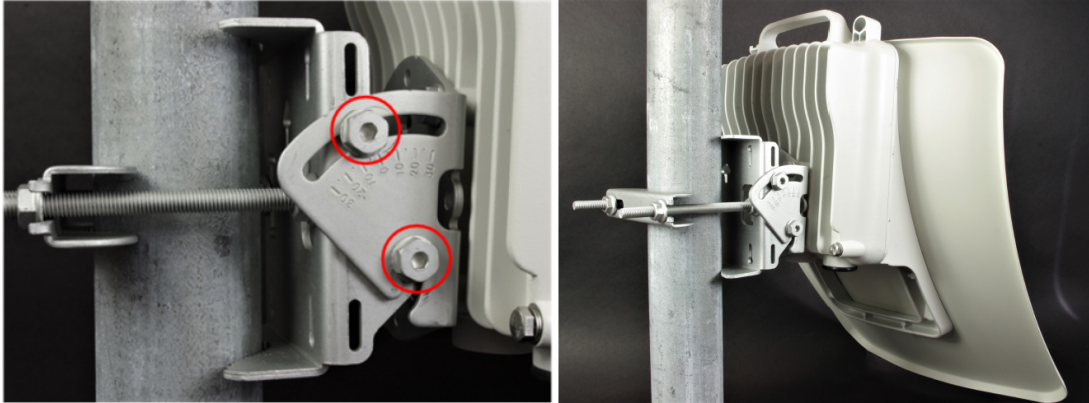

V3000/V5000 Tilt bracket assembly with band clamps

Follow the below instructions to assemble the tilt bracket with band clamps:

1. Follow Step 1 of the [V3000 tilt bracket assembly](#) procedure.
2. Feed the band clamps through the slots in the bracket body. Secure the bracket body to the pole using band clamps (not supplied by Cambium), ensuring that the arrow in the body is pointing upwards. Adjust the azimuth angle, and tighten the band clamps to a torque setting of 6.0 Nm (4.5 lb ft).
3. Fix the mounting plate to the bracket body with four of the short bolts, using a 13 mm spanner or socket. Adjust the elevation angle, and tighten the bolts to a torque setting of 5.0 Nm (3.7 lb-ft).

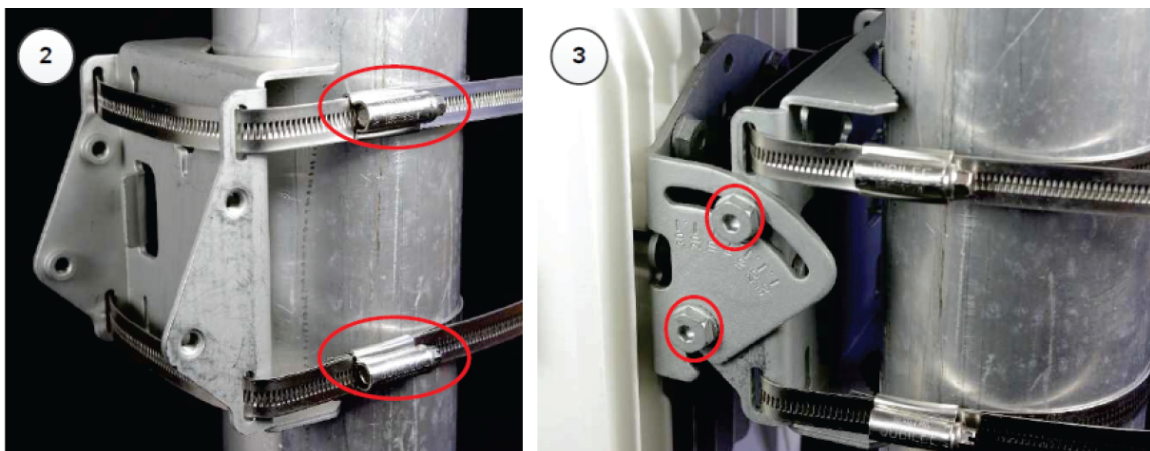

V5000 Pole mount bracket

1. Pass the long screws through the bracket body. The screws are located in the recess in the bracket.

2. Fit two flanged nuts to the long screws on the back of the bracket. Tighten the nuts using a 13 mm spanner.
3. Fix the bracket to the back of the radio using the four short M6 bolts, ensuring that the arrow in the plate points towards the top of the radio. Tighten the four bolts to a torque setting of 5.0 Nm (3.7 lb ft) using a 13 mm spanner or socket.
4. Attach the pole-mount bracket to the pole using the clamp and the remaining flanged nuts. Adjust azimuth and tighten the nuts to 10 Nm (7.4 lbft) using a 13 mm spanner.

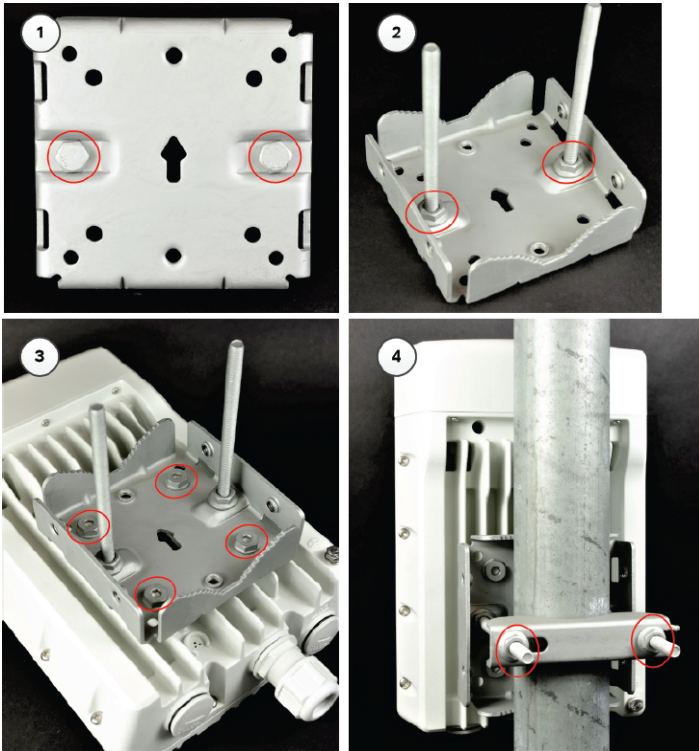

V5000 Alignment

The V5000 distribution node has two sectors, situated side by side, each covering 140 degree range in azimuth, giving a combined coverage of 280 degrees. In elevation, the antenna can beam steer in a +/- 20 degree range. The boundary between where Sector 1 ends and Sector 2 begins is the centre line or boresight from the unit.

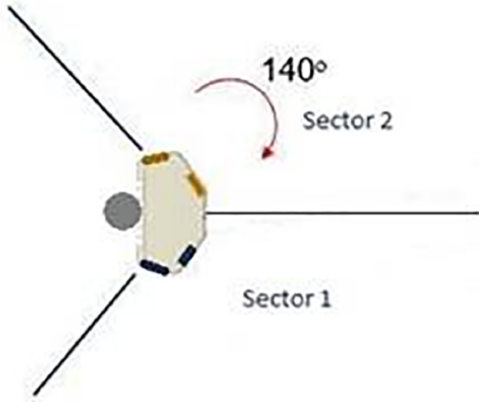

V5000 Wall mount bracket

1. Install the mounting plate of the wall mount bracket securely on a vertical wall, using suitable fixings.



Note

Fixing hardware is not supplied with the wall mount bracket.

2. Fix the bracket body to the back of the radio using the four short M6 bolts, ensuring that the arrow in the plate points towards the top of the radio. Tighten the four bolts to a torque setting of 5.0 Nm (3.7 lb-ft) using a 13 mm spanner or socket.
3. Insert the four short M8 bolts into the sides of the bracket body.
4. Fit the bracket body to the mounting plate by positioning the short bolts into the open-ended slots.

5. Tighten the bolts to a torque setting of 5.0 Nm (3.7 lb-ft) using a 13 mm spanner or socket.

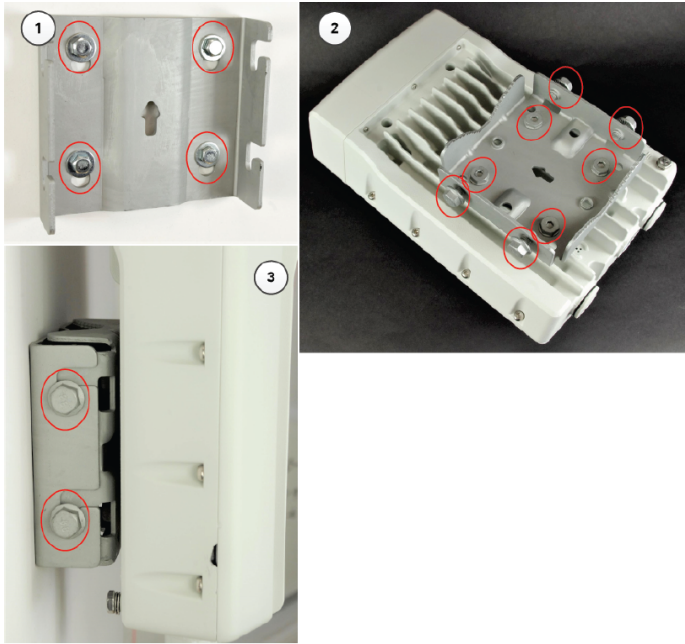

Connecting 60 GHz cnWave Products

This topic provides details on how to install, connect, and power up the 60 GHz cnWave products.

Installing PSU and powering the ODU

Install one of the following types of PSU:

- 60W DC power injector
- AC/DC power supply
- 15W or 30W power injector

Table 2: Details of PoE injector to be used for cnWave 60 GHz products

Product	Without AUX POE Enabled	With AUX POE enabled
V1000	15W	Not applicable
V2000	30W	60W
V3000	60W	60W
V5000	60W	100W



Warning

Always use an appropriately rated and approved AC supply cord-set in accordance with the regulations of the country of use.



Attention

Utilisez toujours un cordon d'alimentation secteur approprié et approuvé conformément aux réglementations du pays d'utilisation.



Attention

As the PSU is not waterproof, locate it away from sources of moisture, either in the equipment building or in a ventilated moisture-proof enclosure. Do not locate the PSU in a position where it may exceed its temperature rating.



Attention

Le bloc d'alimentation n'étant pas étanche, placez-le à l'écart des sources d'humidité, que ce soit dans le bâtiment de l'équipement ou dans une enceinte ventilée étanche à l'humidité. Ne placez pas le bloc d'alimentation dans une position où il pourrait dépasser sa température nominale.



Attention

- Do not plug any device other than a 60 GHz cnWave ODU into the ODU port of the PSU. Other devices may get damage due to the non-standard techniques employed to inject DC power into the Ethernet connection between the PSU and the ODU.
- Do not plug any device other than a Cambium 60 GHz cnWave PSU into the PSU port of the ODU. Plugging any other device into the PSU port of the ODU may damage the ODU and device.



Attention

- Ne branchez aucun périphérique autre qu'une ODU cnWave 60 GHz dans le port ODU du bloc d'alimentation. D'autres appareils peuvent être endommagés en raison des techniques non standard utilisées pour injecter une alimentation CC dans la connexion Ethernet entre le bloc d'alimentation et l'ODU.
- Ne branchez aucun périphérique autre qu'un bloc d'alimentation cnWave Cambium 60 GHz dans le port PSU de l'ODU. Brancher tout autre périphérique sur le port PSU de l'ODU peut endommager l'ODU et le périphérique.

Installing the 60W DC power injector

1. Connect the input side of the DC power injector to the AC power line.

Figure 18: 60W DC power injector and powering diagram

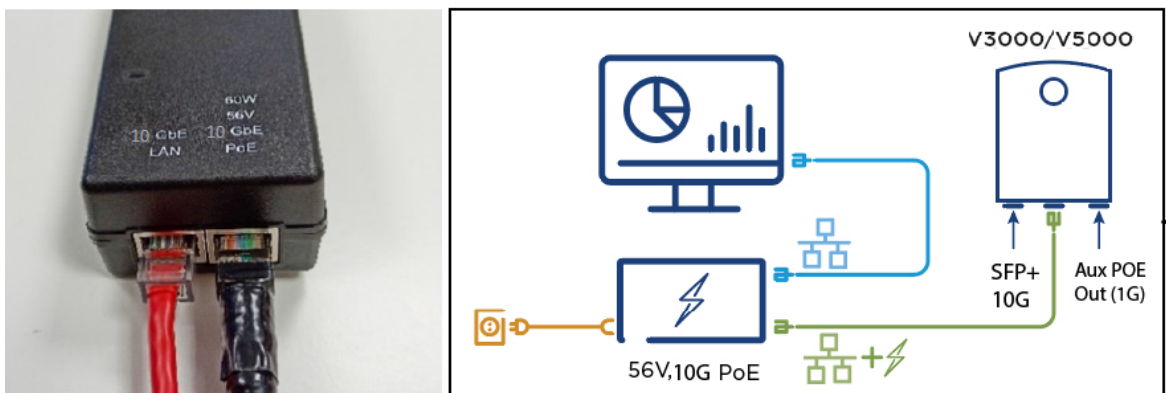

2. Connect 10 Gbe LAN port of the power injector to network equipment.
3. Connect 60 W 56V 10 GbE PoE port of the power injector to ODU drop cable (ODU can be either V3000 or V5000).



Note

For V2000, use the 60 W device, especially when POE Out is required, and the 5 GbE PoE (000000L142A).

Figure 19: Connecting the power injector to ODU drop cable

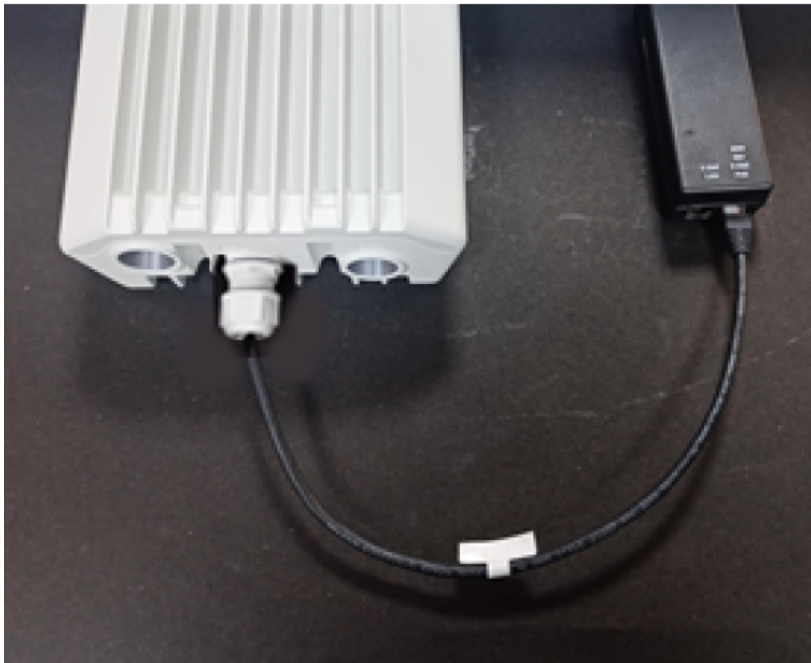

Installing the AC/DC PSU

1. Connect the Input side of the AC/DC PSU to the AC power line.
2. Connect the Output side of DC PSU to ODU through cable joiner and DC mini adapter.

Figure 20: AC/DC PSU (N000000L179B)



Figure 21: Cable joiner



Figure 22: DC to RJ45 plug, Mini adaptor



Figure 23: AC/DC powering diagram

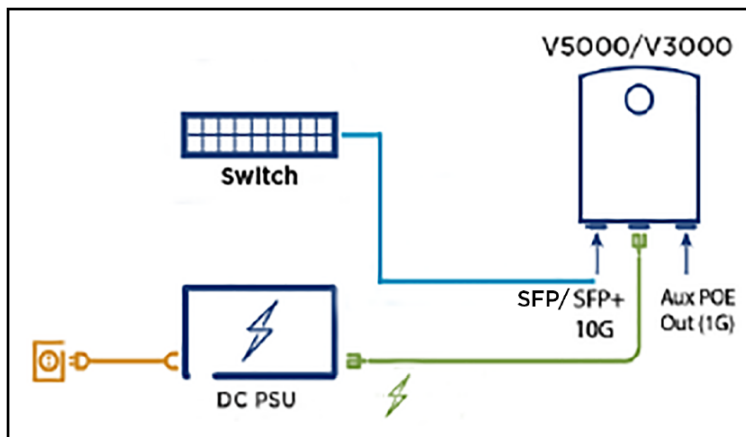

Figure 24: AC/DC PSU



For more information about the installation, refer to the *60 GHz cnWave™ User Guide*.

Installing 15W or 30W power injector

1. Connect the 56V Gigabit Data and power port to ODU (which can be either V1000 or V2000).

Figure 25: V1000 Power injector



Figure 26: V2000 Power injector

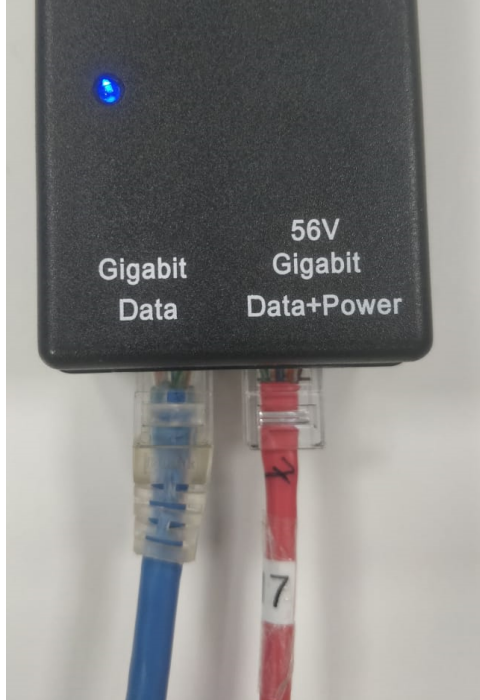

Note

30 W (N000000L034B) supports up to 5 GbE.

Figure 27: V1000 or V2000 Powering diagram

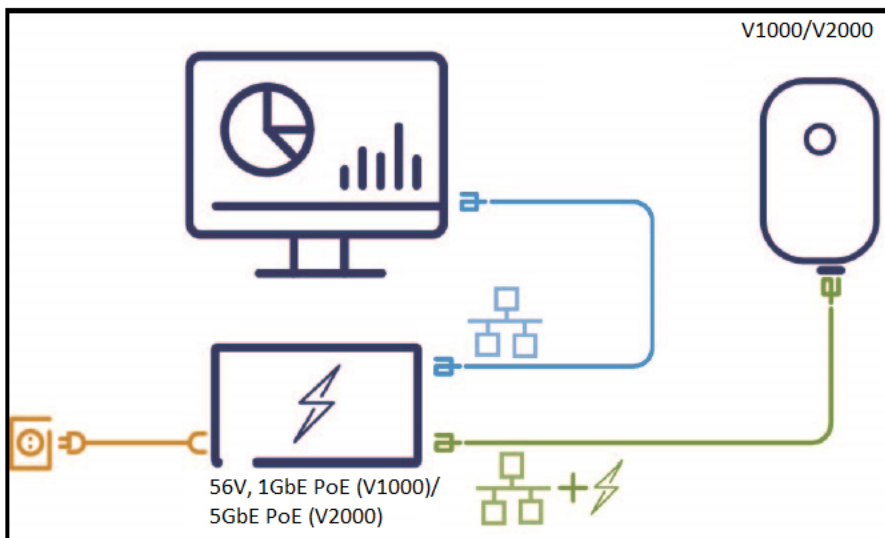

Figure 28: Connecting the V1000 Power injector



Figure 29: Connecting the V2000 power injector



2. Connect the Gigabit data port to the network equipment.

For more information on how to install power injector for all the cnWave 60 GHz platforms, refer to the *60 GHz cnWave™ User Guide*.

Operation

This topic provides a brief description of the theory of operation.

The 60 GHz cnWave devices support Facebook connectivity Technology called Terragraph. The cnWave devices are implemented using IEEE 802.11ay WLAN standard and using 60GHz frequency band for wider spectrum and higher capacity. cnWave devices can provide multi-gigabit throughput from 100M to 1.5 KM.

For the deployment of the devices, Open/R based layer3/IPv6 Mesh is used for efficient distribution of traffic between the nodes and higher availability of the traffic. This will also overcome non-Line of sight issues.

Devices use TDMA/TDD technology to achieve density deployment efficiency. The Network and the nodes are configured, controlled and monitored by a cloud-based E2E controller. Following terminology is used for the network deployment:

- **Distribution node (DN)** - DN connects with other DN for mesh network
- **Client node (CN)** - CN connects to DN to provide high-speed connectivity
- **PoP** - DN connected to the backhaul
- **CPE** - Customer premises devices like Wi-Fi router.

Figure 30: Theory of operation

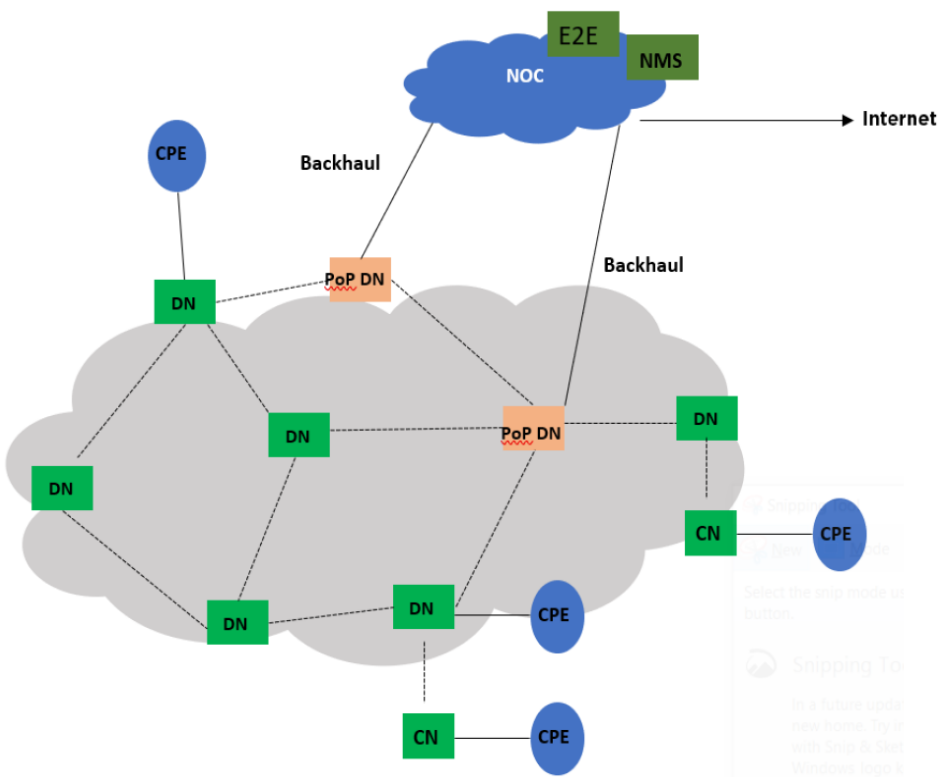

Configuration and Alignment

All configurations are done on E2E Controller, except for the initial configuration, to connect the PoP DN to E2E Controller. The configuration parameters are:

- PoP
- PoP/DN/CN

Deployment of nodes

The configuration of cnWave nodes is handled automatically by the E2E service. However, the first PoP node must be configured manually since connectivity to the E2E controller has not yet been established. After establishing communication with the E2E controller, the nodes report a hash of their local configuration file, and the controller automatically pushes configuration changes to the nodes upon seeing any mismatches. The centralized configuration management architecture is implemented in which the E2E controller serves as the single point of truth for configurations in the network.

Figure 31: Nodes' deployment

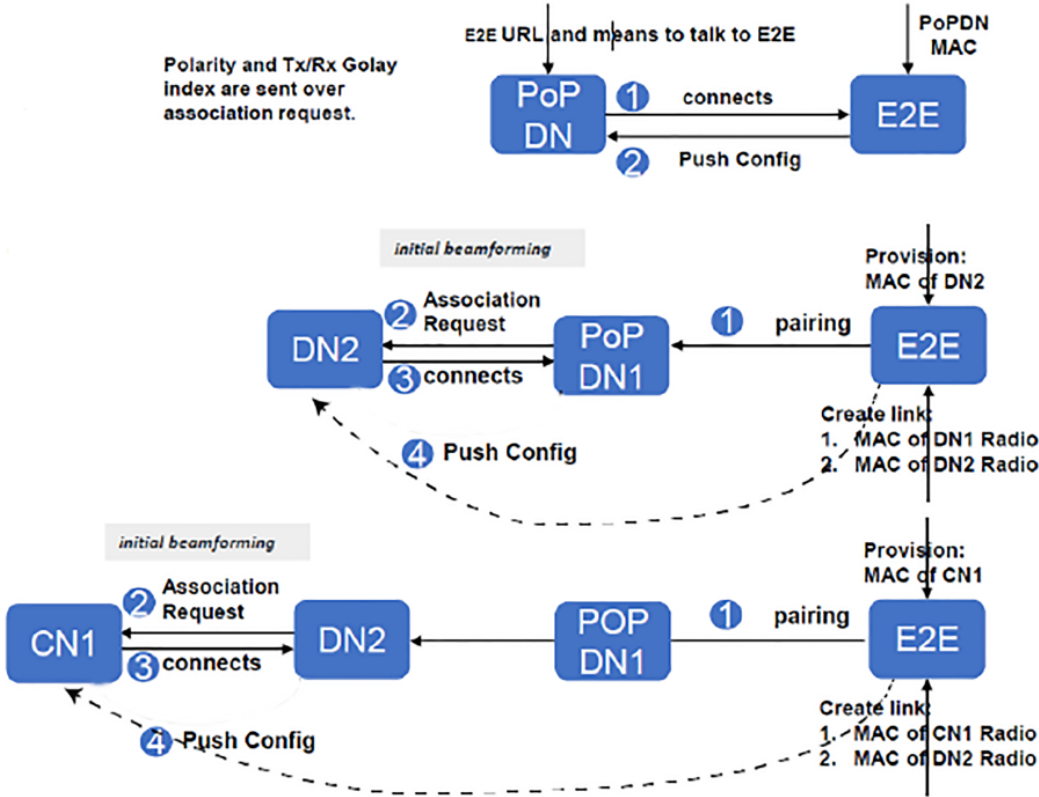

For information on configuring 60 GHz cnWave, refer to the 60 GHz cnWave™ User Guide.

Antenna alignment

The Antenna Alignment tool assists in optimizing the alignment of V3000 to V3000, V5000, V2000, or V1000. This feature helps you to install and align the devices to achieve optimal performance.



Warning

The antenna alignment tool is not a substitute for optical alignment. The optical alignment is the key to get the signal within the +/-2 degree azimuth and +/-1 degree Elevation window. At this window level, the tool can be used to get away from the edge, corner or spurious beams to ensure optimal alignment.

Prerequisite tasks:

- Complete a Link Plan with the help of a Link Planner from Cambium Networks. This prerequisite task provides the information on the RSSI expected for the PTP link. This must be used as target while using the antenna alignment tool.
- Enter the PTP topology in cnMaestro or in the UI of a device (with the Onboard Controller on it). Then, ensure that the following tasks are performed:
 - Creating two Sites and nodes.
 - Setting up the wireless link between the two nodes.
- Ensure that the nodes are already mounted at the sites.
- An installer must have access to the UI of the device.



Note

When the antenna alignment test is executed between the following devices, ensure that GPS is disabled at the CN side:

- V3000 PoP and V1000 CN
- V3000 PoP and V2000 CN
- V3000 PoP and V3000 CN

Using the Antenna Alignment tool

To use the Antenna Alignment tool, perform the following steps:

1. Log on to the device UI by using appropriate URL, username, and password.
The landing page appears.
2. From the landing page, navigate to **Tools > Antenna Alignment**.
The Antenna Alignment page appears, as shown in [Figure 32](#).

Figure 32: The Antenna Alignment page

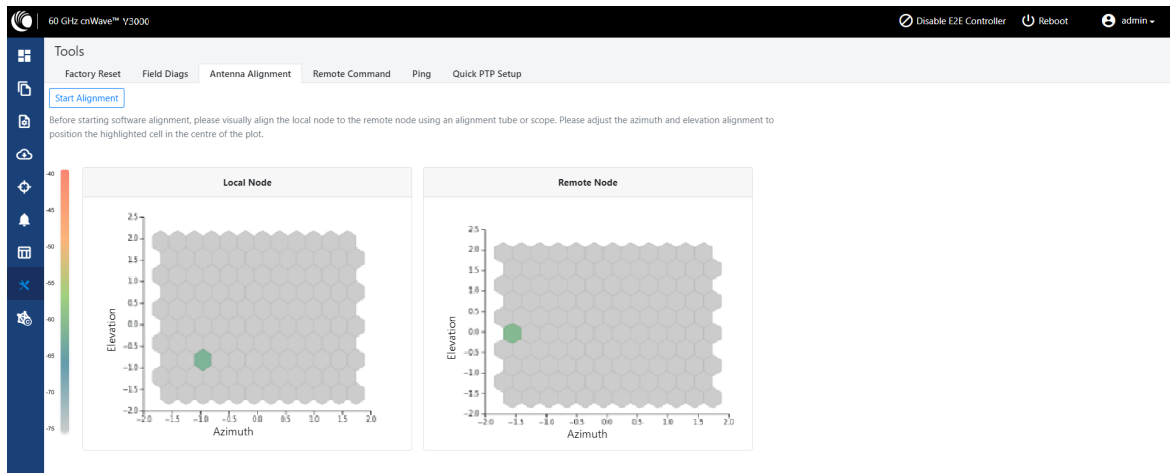

Note

If the alignment is initiated from a CN, ensure that the operating channel is set on the radio (before alignment). If the channel is not set, you must set the required channel in the Configuration page of the V3000 single node UI.

3. Click the **Start Alignment** button located at the top left side of the Antenna Alignment page.

The **Confirm** message box appears, indicating that the link will be disrupted. For running the antenna alignment tool, the auto ignition needs to be disabled. If a link has been established already, it is disassociated at this level. Figure 33 shows how the **Confirm** message box looks.

Figure 33: The Confirm message box in the Antenna Alignment page

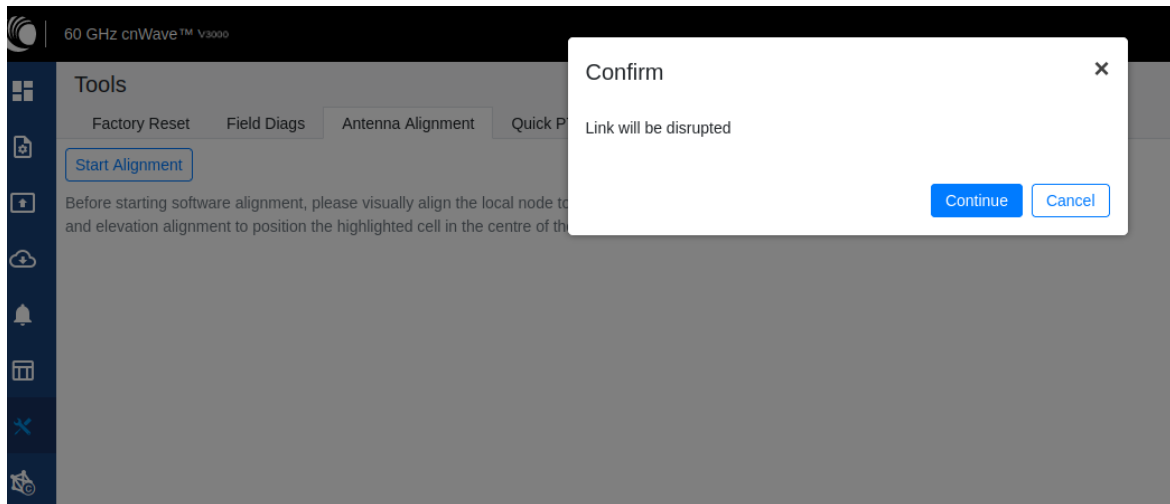

4. In the **Confirm** message box, click **Continue** to start the antenna alignment process.
The antenna alignment process begins.



Note

If the alignment is initiated from a device (which is not running with Onboard Controller), perform the following actions:

- Disable the ignition of the link at the Controller.
- Send Dis-assoc for the link from the Controller.
- When the alignment starts, select the required node from the **Remote Node Model** drop-down list.

The **Time Frame** section populates the RSSI time series as shown in [Figure 34](#).

Figure 34: The RSSI time series

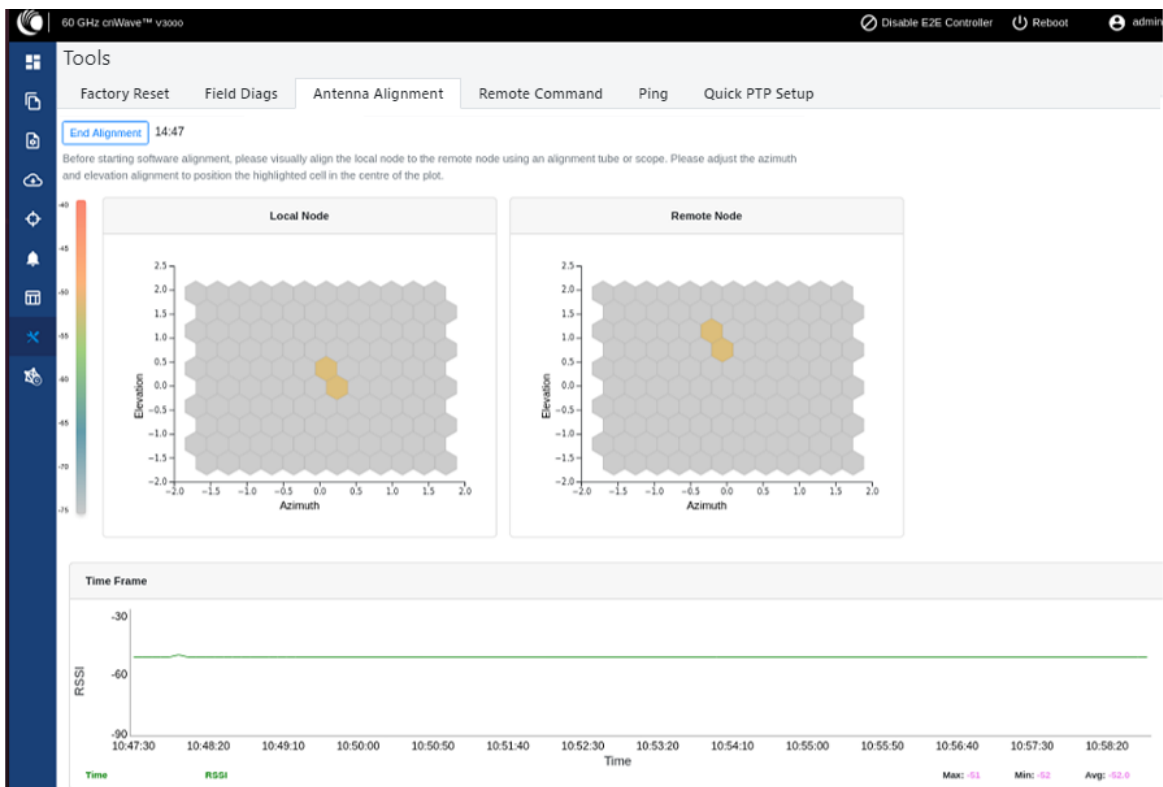

Following details explain about the RSSI time series that populates in the Antenna Alignment page:

- The **Local Node** section (located at the left side of the Antenna Alignment page) displays the direction of arrival angle with respect to the local (PoP) device.
- The **Remote Node** section (located at the right side of the Antenna Alignment page) displays the direction of arrival angle with respect to the remote device.
- In **Local Node** and **Remote Node** sections, a cell marks the direction of arrival. The color of the cell represents the RSSI based on the heatmap scale given on the left side.

- The **Time Frame** section (located at the bottom of the Antenna Alignment page) displays the RSSI time series, along with the peak RSSI time and the latest data point (on the right end of the plot).

The RSSI time series and the heatmap plots get updated every six seconds. This is due to the processing time taken for a complete sweep of all the combinations of beams and channels.

During the alignment phase, the transmit power used is the maximum configured power and the transmit power control is disabled.



Note

If the installer has enabled the short-range installation in the radio configuration, the transmit power control is set to the minimum configured power.

5. Adjust the optimal RSSI that must be reached when the beams are close to the central region, as shown in [Figure 35](#).

Figure 35: *The optional RSSI alignment*

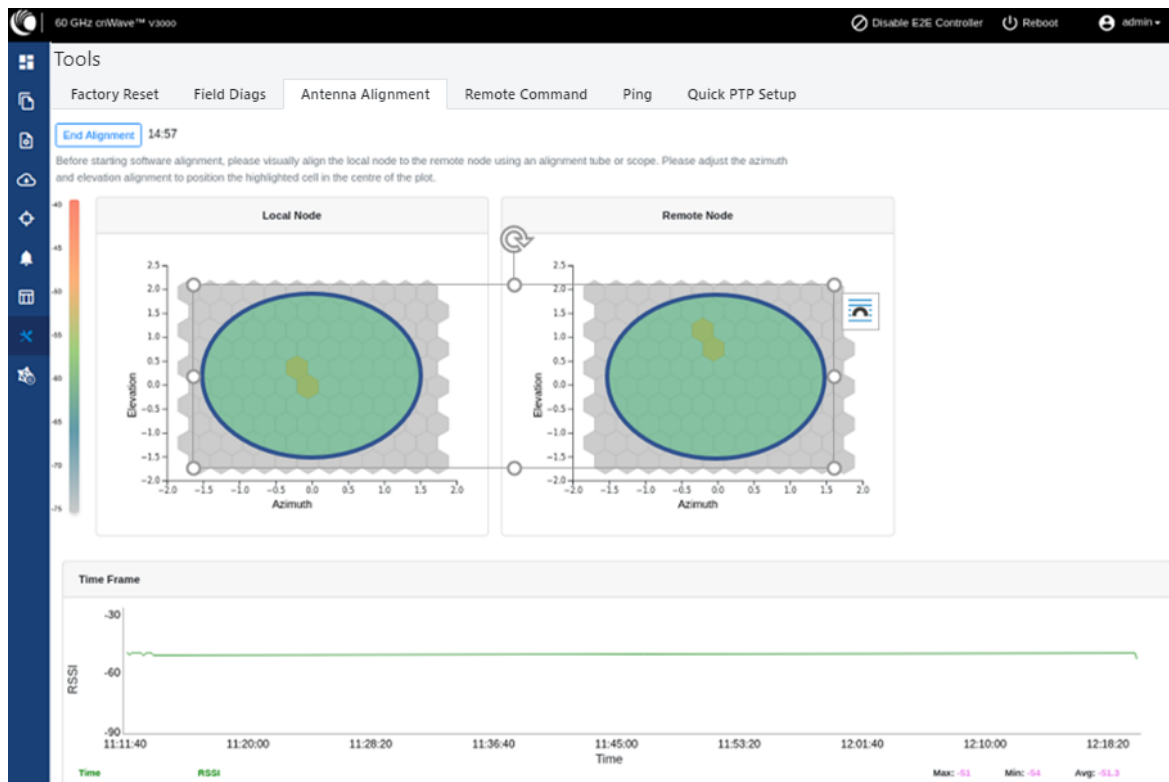

The RSSI time series must be close to the Link planner's predicted RSSI (the receive level when aligning, as shown in [Figure 36](#)), with an error of +/-5dB. Consider the following points when adjusting the optional RSSI:

- If the time series reporting RSSI is more than 10dB from that of the Link Planner's expected RSSI, then the device has been aligned incorrectly and is being picked up by the sidelobes or spurious beams.

- If a cell is highlighted and the time series reporting RSSI is more than 10dB off the expected RSSI, then it is necessary to sweep beyond the current position of both azimuth and elevation, in turn to ride past the sidelobes.

Figure 36: An example of the receive level when aligning - Link planner

Radio Commissioning Notes for CN	
Model	V3000
Maximum EIRP	60 dBm
Minimum MCS	MCS 2
Maximum MCS	MCS12 (16QAM 0.75 Sngl)
Channel	64.80 GHz (Channel 4)
Polarity	Auto
Predicted Receive Power	-46 dBm \pm 5 dB while aligning
Operational EIRP	46 dBm
Operational Receive Power	-60 dBm \pm 5 dB
Predicted Link Loss	116.25 dB \pm 5.00 dB

6. Make use of the direction of arrival information (if there is any elevation or azimuth mismatch) to physically align the radio antennas.
 - When there is an elevation mismatch (as shown in Figure 37):

Figure 37: Example of the elevation mismatch

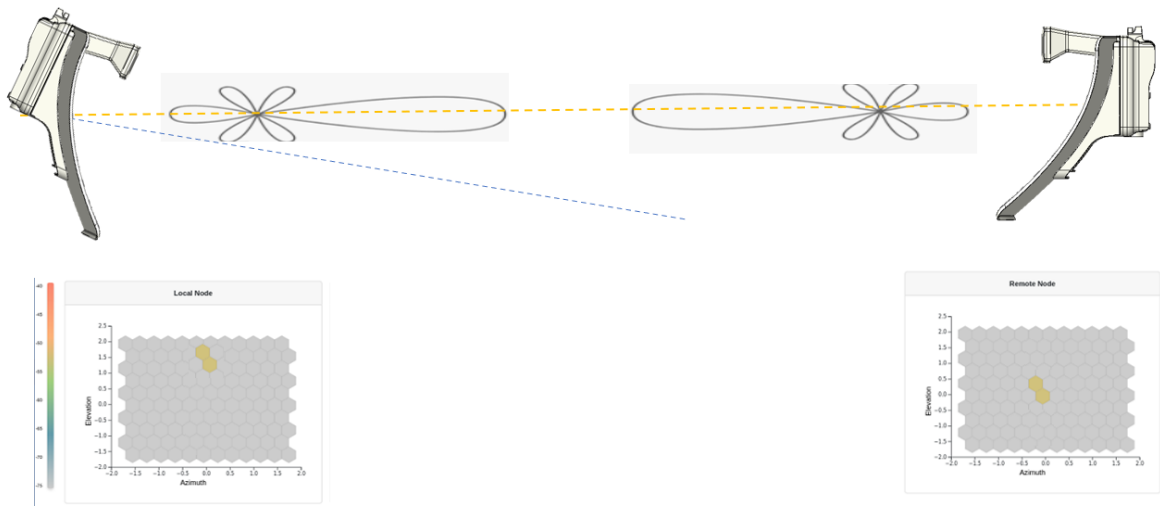

In Figure 37, the angles are exaggerated to show the point. In this example, consider that the radio has been misaligned by a down-tilt of 2 degrees behind the unit (from an installer's view side). This means that the angle of the beam selected might be in the +2 degrees direction in the elevation due to beamforming. The aim is to get the optimal boresight beam. Therefore, the radio must be up tilted in the elevation direction by 2 degrees. The selected beam is now closer to the boresight beam, as shown in Figure 38.

Figure 38: On correcting the elevation mismatch

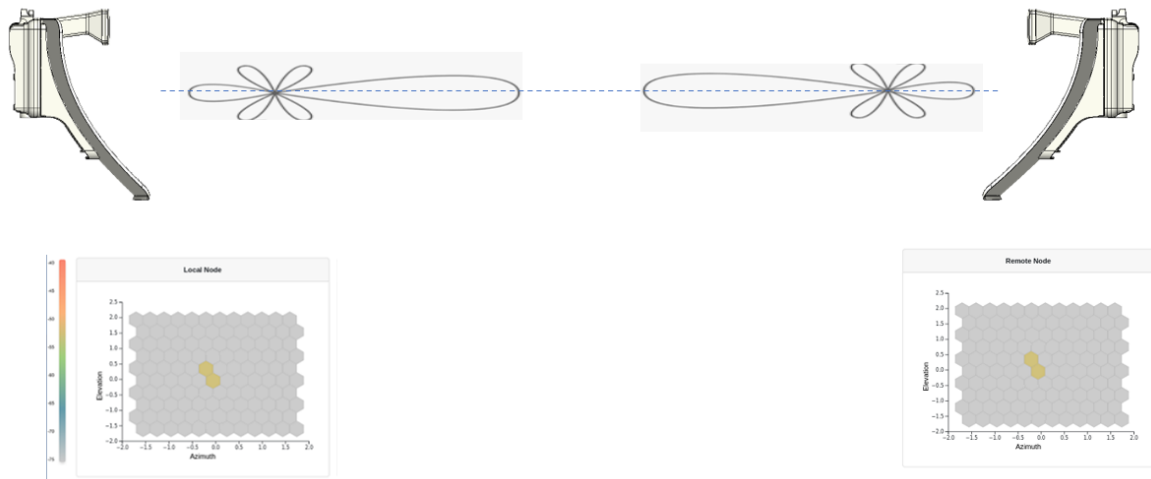

- When there is an azimuth mismatch (as shown in Figure 39):

Figure 39: Example of the azimuth mismatch

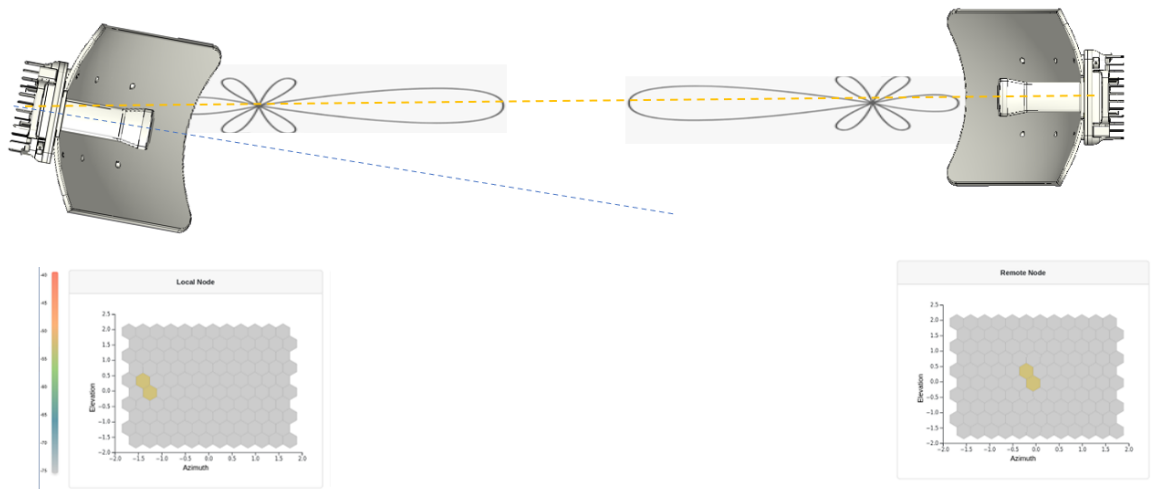

In Figure 39, the angles are exaggerated to show the point. In this example, consider that the radio has been misaligned in azimuth by 2 degrees to the right behind the unit (from an installer's view side). This means that the angle of the beam selected might be in the -2 degrees direction due to beamforming. The aim is to get the optimal boresight beam. Therefore, the radio must be tilted in the azimuthal direction to the left by 2 degrees. The selected beam is now closer to the boresight beam, as shown in Figure 40.

Figure 40: On correcting the azimuth mismatch

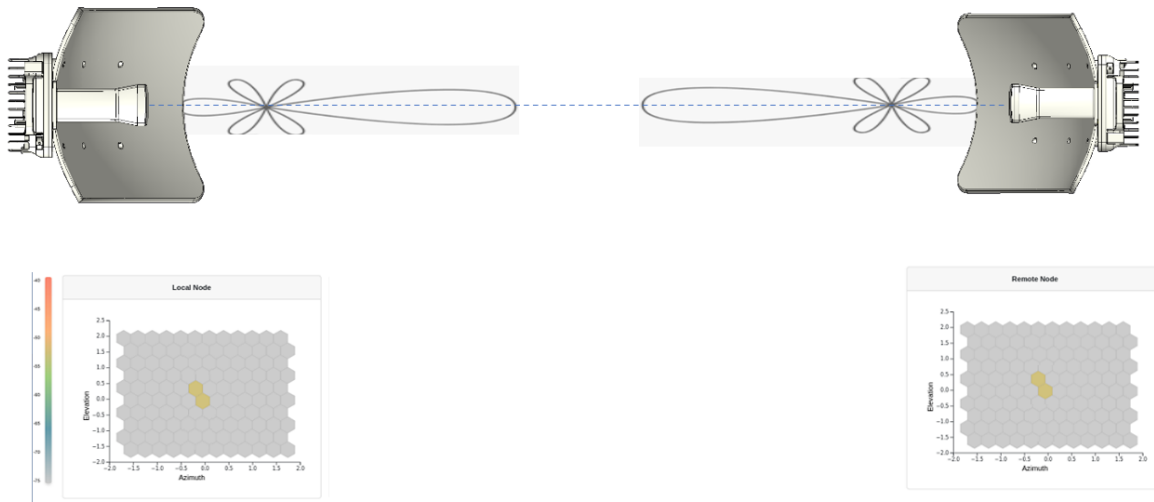

- When you achieve the desired alignment and RSSI, click the **End Alignment** button located at the top left side of the Antenna Alignment page.

If you do not click the **End Alignment** button, the alignment cycle ends automatically after 15 minutes. When the alignment cycle ends, the ignition state (disabled earlier) is enabled to auto ignition and the link is established. Figure 41 shows how the Antenna Alignment dashboard page looks on completing the antenna alignment task.

Figure 41: The updated Antenna Alignment dashboard page

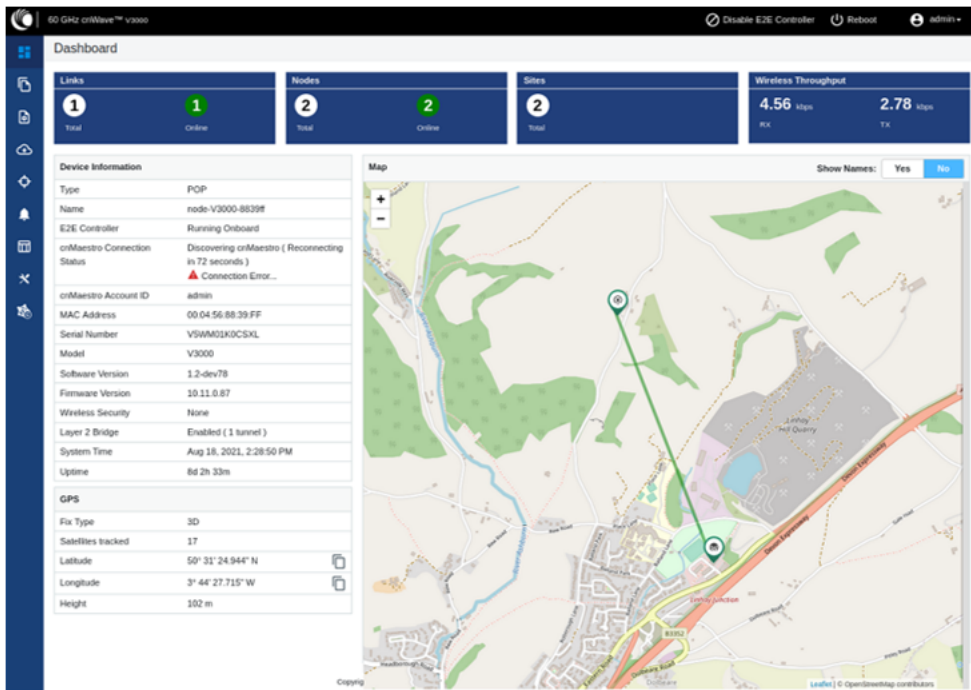

For more information about the UI and configuration, refer to the *60 GHz cnWave™ User Guide*.

Bridge-in-a-Box - Getting Started

Bridge-in-a-Box is an outdoor wireless Ethernet bridge from Cambium Networks. It is useful for business and residential users to wirelessly extend their networks, by connecting from point A to point B in a simple way.

This topic contains the following sections:

- [Bridge-in-a-Box solutions](#)
- [Package contents](#)
- [Features](#)
- [Benefits and use cases](#)
- [Hardware installation](#)
- [Configuration](#)
- [Support contacts](#)

Bridge-in-a-Box solutions

Cambium Networks offers the following Bridge-in-a-Box solutions:

- **Bridge-in-a-Box 60 GHz 1Gb**



- **Bridge-in-a-Box 60 GHz 2Gb**



Package contents

Each Bridge-in-a-Box variant comes with two wireless radio modules and Power over Ethernet (PoE) supplies.

You can use these modules to extend your network from one location where you have an Ethernet port to another location where you need one.

Following figure is an example of Bridge-in-a-Box modules in a package.

Bridge-in-a-Box 1Gb (V1000)



Bridge-in-a-Box 2Gb (V2000)



Features

The following table lists the features of each Bridge-in-a-Box solution.

Feature	Bridge-in-a-Box 1Gb	Bridge-in-a-Box 2Gb
Frequency	60 GHz	60 GHz
Data rate	Up to 1 Gbps	Up to 1.8 Gbps
Range	150 m or 500 ft	1 km or 0.6 mi
Wireless standard	802.11ay standard	802.11ay standard
Wired interface	1 x 100/1000 BaseT with PoE In	1 x 2.5 GbE PoE Input 1 x 2.5 GbE PoE 802.3at Output
Radio power	Up to 38 dBm EIRP	Up to 49 dBm EIRP
Antenna	22.5 dBi	34.5 dBi
Environmental	IP66/67	IP66/67
Operating temperature	-40°C to 60°C (-40°F to 140°F)	-40°C to 60°C (-40°F to 140°F)
Mounting range	25 mm to 70 mm (1 inch to 2.75 inches)	25 mm to 70 mm (1 inch to 2.75 inches) Note: Bracket provides fine adjustment of up to +/-20° in elevation.
Security	128-bit AES encryption	128-bit AES encryption

Benefits and use cases

The following table lists benefits and use cases of Bridge-in-a-Box.

Benefit	Use case
Extended Internet connectivity	Bridge-in-a-Box is used for connectivity at: <ul style="list-style-type: none"> • Machine shops, garages, or storage sheds • Docks or boat ramps • Remote or outlying buildings, remote parking lots, campus building, or building to building • Cabins, lodges, or construction sites • Events such as concerts, farmer markets, or athletic fields and events
Remote Wi-Fi hotspot connectivity	
Remote camera or CCTV video feed	

Hardware installation

The radio modules and PoE supplies (which come with each Bridge-in-a-Box on purchasing) are easy to deploy as they come pre-configured and pre-paired to connect. You must unbox and directly install the units without any further configuration or other procedures such as node or link creation.

Following quick steps explain on how to install a new Bridge-in-a-Box module:

1. Attach the bracket to the pole using the pole mount, adjust the position, and mount the device securely.
2. Attach the Ethernet cables to the port to secure the cable gland. Then, attach the grounding cable.
3. Connect the PoE with the module.
4. Establish the connection.
5. Configure the module, as described in the [Configuration](#) section.

Your network is now connected.

For detailed information on installing the radio units, refer to the Installation section in the *60 GHz cnWave™ User Guide*.



Note

The same quick steps are illustrated [here](#) in detail.

Configuration

By default, the Bridge-in-a-Box modules are pre-configured and pre-paired to connect easily. When the hardware installation is complete and has a proper Line of Sight (LoS), the link is established between the Controller node and the client nodes (CN) automatically.

You can log on to the device user interface (UI) using the default IP address (169.254.1.1 for the Controller node and 169.254.1.2 for the CN node). You can view the connected Controller and CN details on the **Topology** page of the device UI. In addition, you can make the required changes using the device UI.



Note

For information on additional configuration changes, refer to the *60 GHz cnWave™ User Guide*.

Support contacts

For more information and support, visit the following websites:

- [About Cambium Networks](#)
- [Support](#)
- [Warranty](#)
- [Global office addresses](#)

Glossary

Term	Definition
CN	Client Node
DN	Distribution Node
E2E Controller	End to End Controller
ODU	Outdoor unit
PSU	Power Supply Unit
RF	Radio frequency
RSSI	Receiver Signal Strength Indicator
UI	User interface

Cambium Networks

Cambium Networks delivers wireless communications that work for businesses, communities, and cities worldwide. Millions of our radios are deployed to connect people, places and things with a unified wireless fabric that spans multiple standards and frequencies of fixed wireless and Wi-Fi, all managed centrally via the cloud. Our multi-gigabit wireless fabric offers a compelling value proposition over traditional fiber and alternative wireless solutions. We work with our Cambium certified ConnectedPartners to deliver purpose built networks for service provider, enterprise, industrial, and government connectivity solutions in urban, suburban, and rural environments, with wireless that just works.

Installation and Configuration Guides	http://www.cambiumnetworks.com/guides
Technical training	https://learning.cambiumnetworks.com/learn
Support website (enquiries)	https://support.cambiumnetworks.com
Main website	http://www.cambiumnetworks.com
Sales enquiries	solutions@cambiumnetworks.com
Warranty	https://www.cambiumnetworks.com/support/standard-warranty/
Telephone number list to contact	http://www.cambiumnetworks.com/contact-us/
Address	Cambium Networks Limited, Unit B2, Linhay Business Park, Eastern Road, Ashburton, Devon, TQ13 7UP United Kingdom

 Cambium Networks™ www.cambiumnetworks.com

Cambium Networks and the stylized circular logo are trademarks of Cambium Networks, Ltd. All other trademarks are the property of their respective owners.

© Copyright 2023 Cambium Networks, Ltd. All rights reserved.