

# Quick Installation Guide

Indoor/Outdoor Access Point/Wireless Bridge

**Setup with videos**  
Visit <https://www.tp-link.com/support/setup-video/?type=smb> or scan the QR code to search for the setup video of your product model.



Note: Images may differ from your actual product.  
© 2024 TP-Link 7106511215 REV1.1.0

## 1 Overview

### Package Contents

We offer single-pack and KIT products. You can purchase according to actual needs. The KIT product will contain two sets of accessories and one Installation Guide.

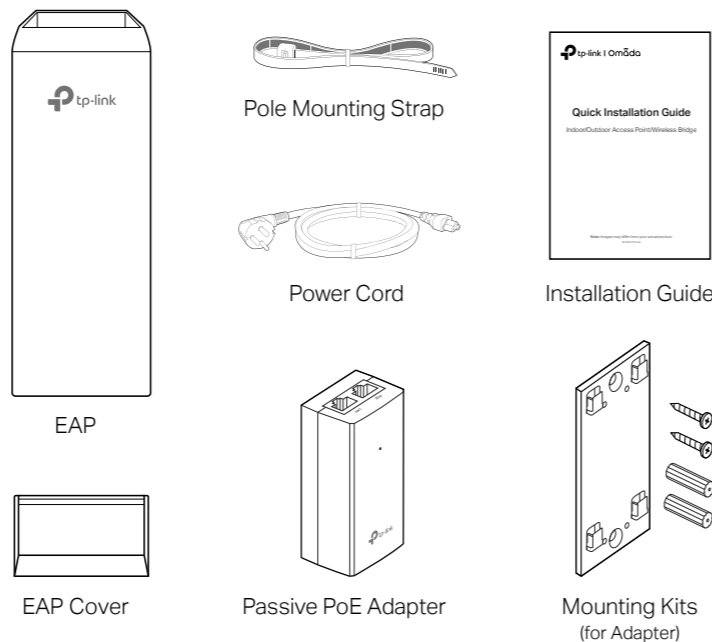

## LED Explanation

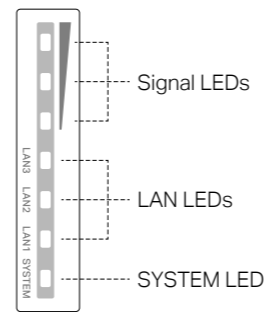

LED	Indication
<b>Signal LEDs</b>	Work as Main AP: All LEDs remain solid on. Work as Sub-AP: More lit LEDs indicates better wireless signal strength.
<b>LAN LEDs</b>	On: The port is connected, but no active. Flashing: The port is connected and active. Off: The port is not connected.
<b>SYSTEM LED</b>	On: Working normally/initializing Off: Working abnormally/Power off/LED is turned off. Flash: • Flash twice: Initialization is completed. • Flash quickly: The EAP is resetting, or the Omada controller is locating the device*. • Flash once per second: The EAP is upgrading. • Flash Slowly: The EAP is in the isolated state.

\* When the Locate feature is activated in the Omada controller, the SYSTEM LED flashes quickly to locate and identify the device. The LED will flash for 10 minutes. You can disable the feature manually to stop it from flashing.

## Panel Layout

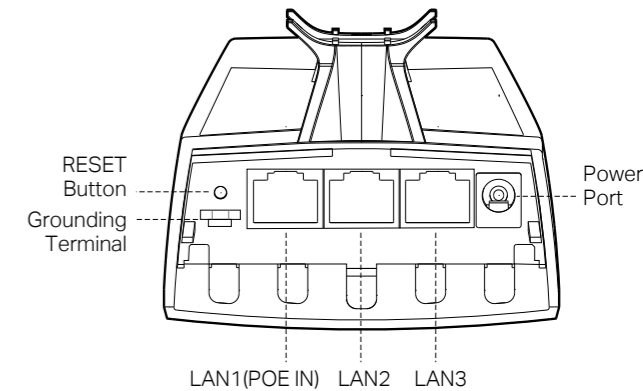

### Passive PoE Adapter

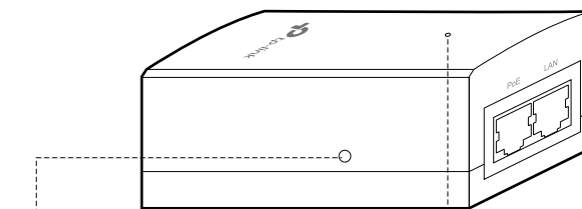

#### Remote Reset:

Press and hold for about 8 seconds until the EAP's Signal and LAN LEDs flash. The EAP will restore factory settings.

#### Power LED:

On: Power on  
Off: Power off

## 2 Site Consideration

### Mounting Height

Ensure a clear line of sight between the wireless devices for an optimum performance. An elevated location is recommended as obstacles like trees, buildings and large steel structures will weaken the wireless signal.

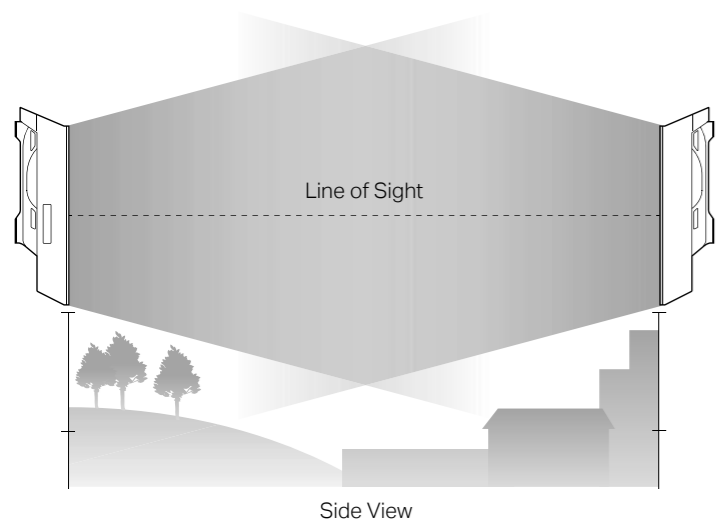

### Orientation

Install the EAP devices with the front facing the intended signal receiving devices. You can orient the devices with the assistance of Google Maps, GPS and some landmarks according to the horizontal beamwidth listed below.

Model	EAP115-Bridge/EAP215-Bridge	EAP211-Bridge
<b>Horizontal Beamwidth</b>	35°	70°

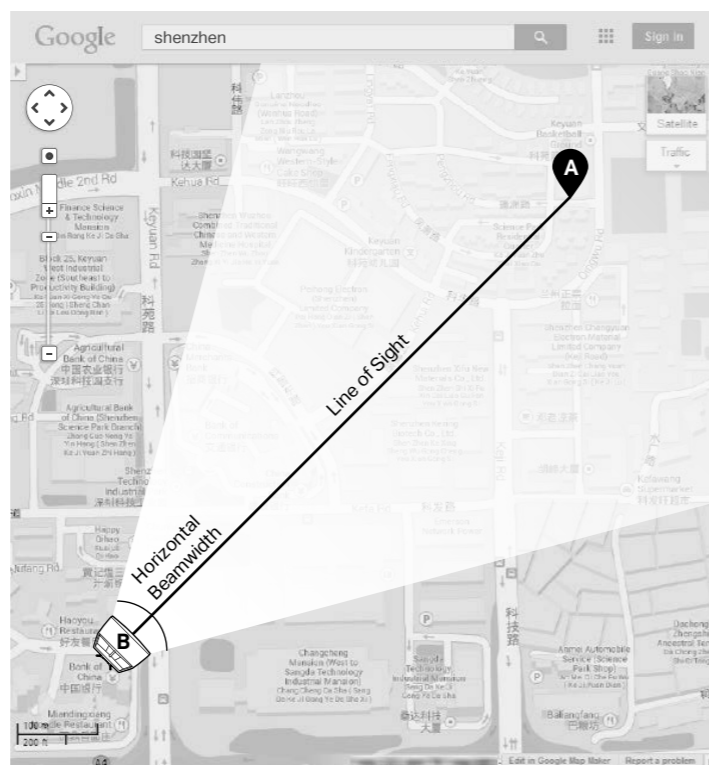

## 3 Hardware Connection

Connect the EAP and power adapter as shown in the figure below.

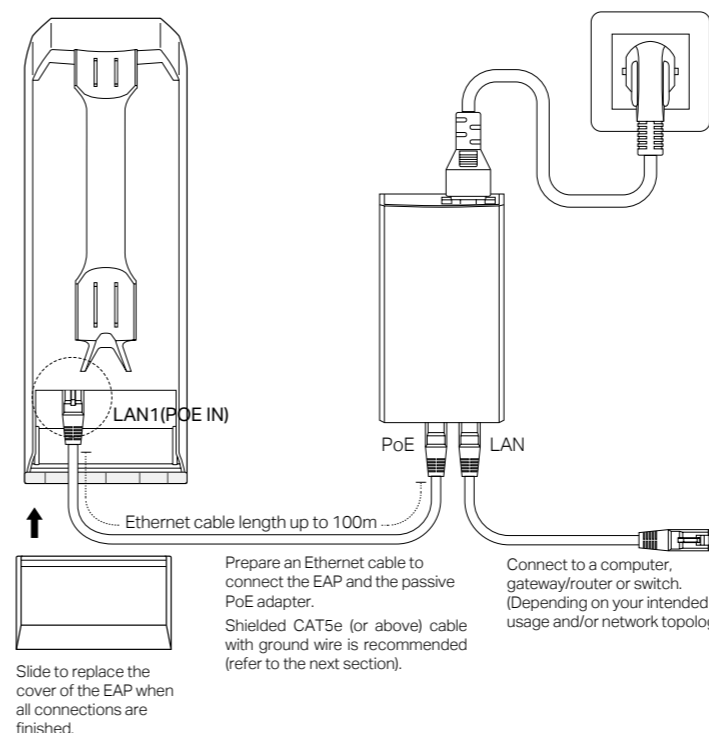

## 4 Lightning and ESD Protection

Before mounting the EAP, consider Lightning and ESD Protection to ensure safety. Proper grounding is extremely important for outdoor devices.

By using shielded CAT5e (or above) cable with ground wire for the connection and the provided PoE adapter (Method 1), you can effectively eliminate ESD attacks.

If you use the general CAT5e cable for the connection, then it is necessary to connect the grounding terminal of the EAP to earth ground through grounding cable (Method 2).

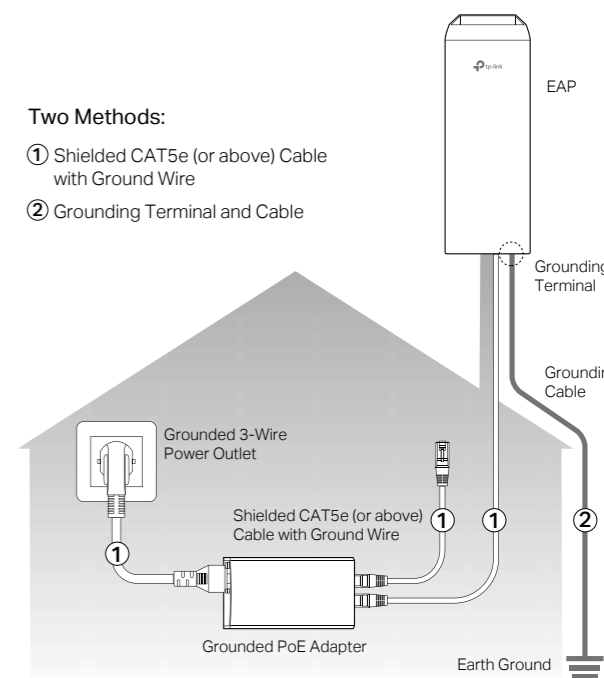

## 5 Mounting

### • Mount the EAP

At the selected site, approximately align the EAP to the direction that you have oriented.

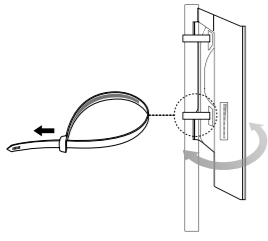

### • (Optional) Mount the Power Adapter

⚠ To ensure the passive PoE adapter is attached most securely, we recommend that you install the adapter with the Ethernet port facing upward.

1. Drill two holes on the wall and insert the wall anchors into the holes. Secure the mounting bracket to the wall. Make sure the shoulders at the corners of the mounting bracket are on the outside and pointing upward.

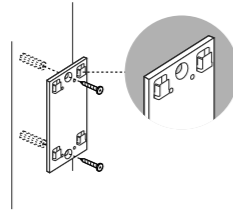

2. Attach the passive PoE adapter to the mounting bracket by sliding the adapter in the direction of the arrows until it locks into place.

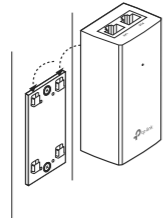

### • Type 2: Omada Hardware Controller

If you have no spare PC to keep running the software controller in the network, you can purchase the hardware controller.

For more details, refer to the Installation Guide of your hardware controller.

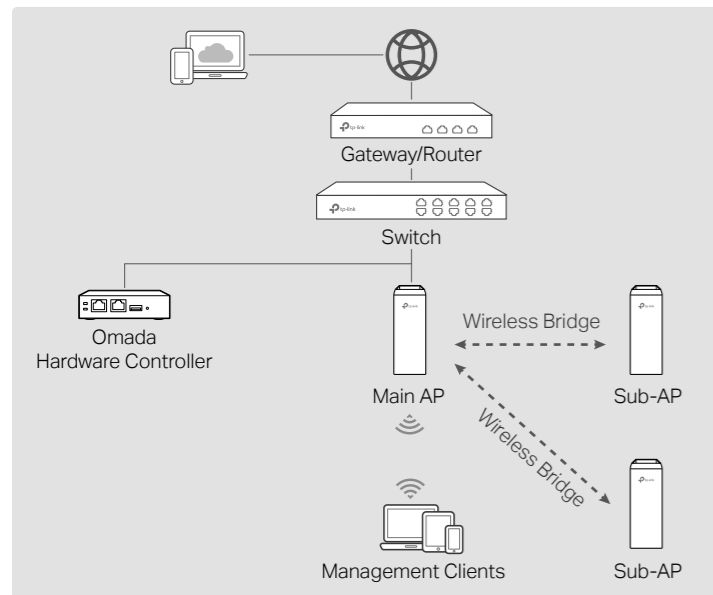

#### Note:

- Before you start, be sure to **power up** and **connect** your devices according to the topology figure.
- A **DHCP server** (typically a gateway/router with DHCP function enabled) is required to assign IP addresses to the EAPs and clients in your local network.
- Omada Controller must have network access to your Omada devices (the gateway/router, switch, and EAPs) in order to find, adopt, and manage them.

## 6 Software Configuration

### • Method 1: Standalone Mode

Configure and manage bridge AP devices with the Main AP (Convenient for a small network with only a few devices)

### • Method 2: Controller Mode

Configure and manage EAPs in batches on a central platform, namely Omada Controller.

### Method 1: Standalone Mode

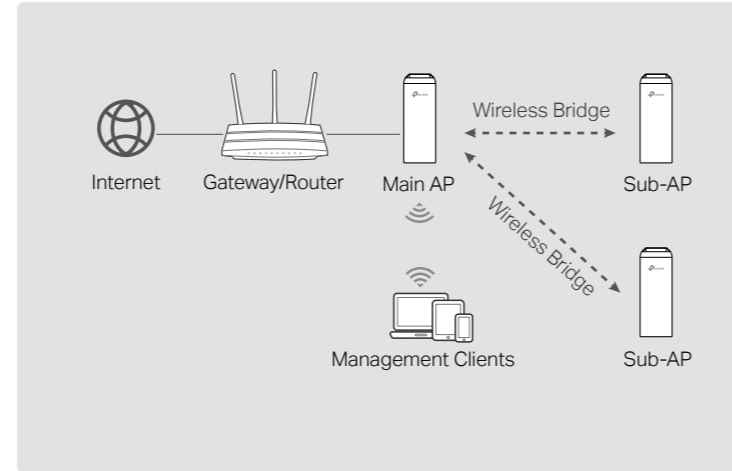

#### Note:

- Before you start, be sure to **power up** and **connect** your devices according to the topology figure.
- A **DHCP server** (typically a gateway/router with DHCP function enabled) is required to assign IP addresses to the EAPs and clients in your local network.

### Via Omada App

1. Download and install the TP-Link Omada App from App Store or Google Play.



2. Launch your Omada App and configure the controller at a local site or remote site.

#### • Local Management

- a. Connect your mobile device to the Main AP by using the default SSIDs printed on the label at the bottom of the product.
- b. Launch the Omada App and go to **Local Access**, tap the + button on the upper-right corner to add the controller. Then you can launch the controller to adopt and manage devices.

#### • Remote Management

**Note:** Before you start, make sure that both your controller and mobile device can access the internet.

##### • For Omada Software Controller:

- a. Make sure that **Cloud Access** is enabled on your controller and your controller has been bound with your TP-Link ID.
- b. Launch Omada App and log in with your TP-Link ID. Then go to **Cloud Access**. A list of controllers that have been bound with your TP-Link ID will appear. Then you can launch the controller to adopt and manage devices.

##### • For Omada Hardware Controller:

- a. Make sure that **Cloud Access** is enabled on your controller. By default, **Cloud Access** is enabled. Make sure that the Cloud LED is flashing slowly.
- b. Launch Omada App and log in with your TP-Link ID. Then go to **Cloud Access**. Tap the + button on the upper-right to add your controller. Then you can launch the controller to adopt and manage devices.

### Via Omada App

1. Download and install the TP-Link Omada App from App Store or Google Play.



2. Connect your mobile device to the Main AP by using the default SSIDs printed on the label at the bottom of the product.
3. Open the Omada App, go to the **Standalone Mode > EAPs** page, and wait for the Main AP to appear. Tap on the AP to configure it.
4. Add the sub-AP(s).

- For the sub-AP in the same KIT as the Main AP, the app will automatically scan for it and add it to the network.
- For other sub-APs, go to the **EAPs** page, tap **Bridge**, then tap + and follow app instructions to manually add them to the network.

**Note:** For security, we recommend changing the default login username and password of each AP.

### Via Web Browser

1. Connect your device to the Main AP by using the default SSIDs printed on the label at the bottom of the product.
2. Launch a web browser and enter <http://tplinkeap.net> in the address bar. Use **admin** for both Username and Password to log in.
3. Set up a new Username and Password for secure management purpose. Then you can configure the Main AP.
4. Add the sub-AP(s).

- For the sub-AP in the same KIT as the Main AP, the system will automatically scan for it and add it to the network.
- For other sub-APs, go to **Management > Wireless Bridge APs**, then click **Add Sub-AP** and follow web instructions to manually add them to the network.

**Note:** For security, we recommend changing the default login username and password of each AP.

### Via Web Browser

1. Open the controller's web page.

#### • For Omada Software Controller:

Launch the software controller on your PC. After the initiation process, the controller automatically opens its web page. If not, click **Launch a Browser to Manage the Network**.

#### • For Omada Hardware Controller:

Find the IP address of the controller on the gateway/router's DHCP client list. Enter the IP address in the address bar to open its web page.

2. On the controller's web page, follow the wizard to complete the quick setup. Then you can launch the controller to adopt and manage devices.
3. (For Remote Management) You can remotely access and manage your controller via Omada Cloud Service.

**Note:** Before you start, make sure that both your controller and PC can access the internet.

#### • For Omada Software Controller:

- a. Make sure that **Cloud Access** is enabled on your controller and your controller has been bound with your TP-Link ID. On the controller's web page, go to **Settings > Cloud Access** to enable Cloud Access and bind your TP-Link ID. If you have set it up in the quick setup, skip this step.
- b. Launch a web browser and enter <https://omada.tplinkcloud.com> in the address bar. Enter your TP-Link ID and password to log in. A list of controllers that have been bound with your TP-Link ID will appear. Then you can launch the controller to adopt and manage devices.

#### • For Omada Hardware Controller:

- a. Make sure that **Cloud Access** is enabled on your controller. By default, **Cloud Access** is enabled. Make sure that the Cloud LED is flashing slowly.
- b. Launch a web browser and enter <https://omada.tplinkcloud.com> in the address bar. Enter your TP-Link ID and password to log in. Click + **Add Controller** and choose **Hardware Controller** to add your controller. Then you can launch the controller to adopt and manage devices.

## Method 2: Controller Mode

Choose from a type of Omada Controller:

### • Type 1: Omada Software Controller

On a PC with Windows or Linux OS, download the software controller from <https://www.tp-link.com/support/download/omada-software-controller/>. Then run the file and follow the wizard to install and launch the controller.

To manage your devices, the software controller needs to keep running on your computer.

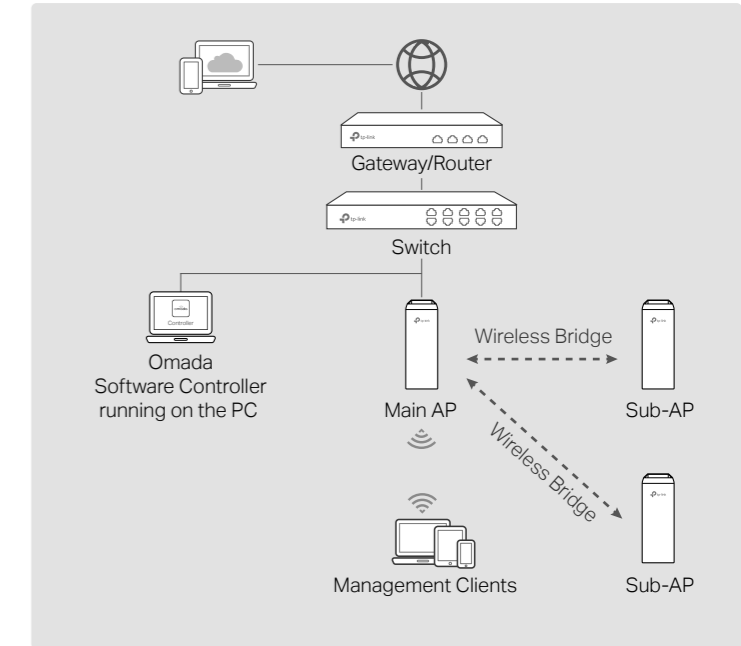

## Safety Information

- Keep the device away from fire or hot environments. DO NOT immerse in water or any other liquid.
- Do not attempt to disassemble, repair, or modify the device. If you need service, please contact us.
- Do not use the device where wireless devices are not allowed.
- Do not use damaged charger or USB cable to charge the device.
- Do not use any other chargers than those recommended.
- Adapter shall be installed near the equipment and shall be easily accessible.
- Use only power supplies which are provided by manufacturer and in the original packing of this product. If you have any questions, please don't hesitate to contact us.
- Adapter should be used indoors where the ambient temperature is lower than or equal to 40°C.
- The plug on the power supply cord is used as the disconnect device, the socket-outlet shall be easily accessible.
- This equipment can be powered only by equipments that comply with Power Source Class 2 (PS2) or Limited Power Source (LPS) defined in the standard of IEC 62368-1.
- Plug the adapter into the wall outlets with earthing connection through the power supply cord.

TP-Link hereby declares that the device is in compliance with the essential requirements and other relevant provisions of directives 2014/53/EU, 2009/125/EC, 2011/65/EU and (EU)2015/863. The original EU Declaration of Conformity may be found at <https://www.tp-link.com/en/support/ce/>.

TP-Link hereby declares that the device is in compliance with the essential requirements and other relevant provisions of the Radio Equipment Regulations 2017. The original UK Declaration of Conformity may be found at <https://www.tp-link.com/support/ukca/>

**Attention:** In EU member states, EFTA countries and Northern Ireland, the operation in the frequency range 5150MHz-5350MHz is only permitted indoors.

**Attention:** In Great Britain, the operation in the frequency range 5150MHz - 5350MHz is only permitted indoors.

For EAP Controller, go to **Access Point** page and select the desired EAP to specify the channel. For web browser, go to **Wireless > Wireless Settings** to specify the channel.

!	AT	BE	BG	CH	CY	CZ	DE	DK	!	UK
	EE	EL	ES	FI	FR	HR	HU	IE		
	IS	IT	LI	LT	LU	LV	MT	NL		
	NO	PL	PT	RO	SE	SI	SK	UK(NI)		

For detailed configurations, please download the User Guide of EAP at: <https://www.tp-link.com/support/download/?type=smb>

To ask questions, find answers, and communicate with TP-Link users or engineers, please visit <https://community.tp-link.com/business> to join TP-Link Community.

For technical support, the user guide and other information, please visit <https://www.tp-link.com/support/?type=smb>, or simply scan the QR code.

