



EasyMesh  
— Compatible —



# AX1500 Next-Gen Wi-Fi 6 Router

Next-Gen Wi-Fi For All



Archer AX18



### Faster Speeds with Wi-Fi 6

Next-Gen faster Wi-Fi speeds up to 1.5 Gbps<sup>†</sup>



### Ultra-Low Latency

Enjoy smooth streaming and gaming with lower latency by Wi-Fi 6<sup>†</sup>



### Connect More, Stay Fast

More simultaneous connections and higher average throughput with OFDMA<sup>†</sup>



### Full Gigabit Ports

Take full advantages of broadband speeds up to 1 Gbps<sup>^</sup>

# Highlights

## Wi-Fi 6 | 802.11 AX<sup>E</sup> Future-Proof Your Wi-Fi

### Improved Efficiency, More Connections

Add more Wi-Fi devices to your network without dragging the performance, as Archer AX18 with Wi-Fi 6 builds a more efficient network that increases the average throughput by 4 times and serves more devices.<sup>§</sup>

### Immersive Gaming, Smooth Streaming

Enjoy stable network for online gaming and live streams with flawless video and clear audio. OFDMA allows clients to transmit both on uplink and downlink using one band at one time, which cut the latency and ensures a responsive network.<sup>‡</sup>

### Broader Coverage, Larger Capacity

With clearer and stronger signal generated with Wi-Fi 6 and Beamforming technology, Archer AX18 delivers data to devices far away by focusing less-interfered wireless signal towards them.

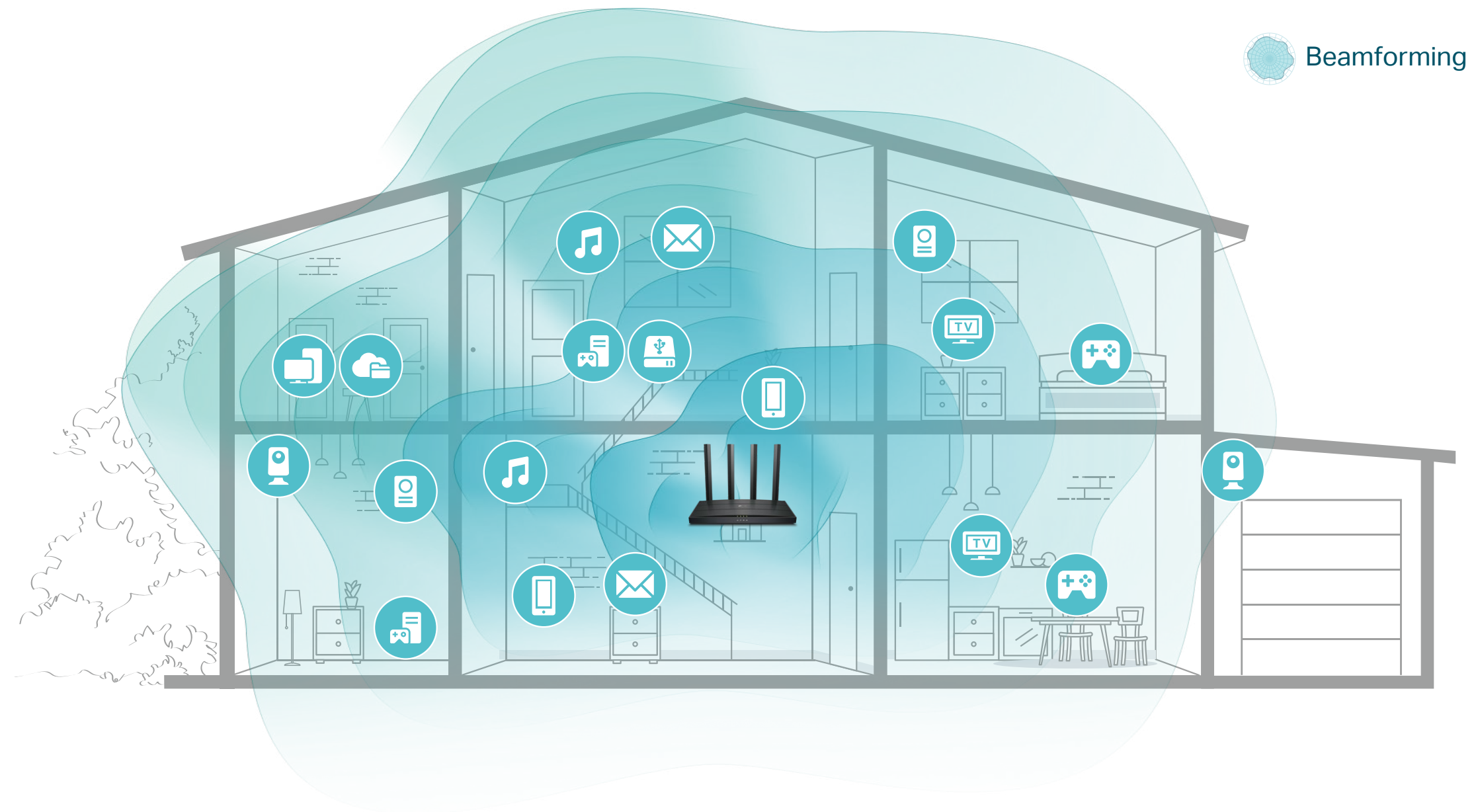

# Highlights

## Faster Wireless Connection

4-Streams Wi-Fi offers connection at over 1 Gbps speed for newer mobile devices, reducing wait time by 30% while downloading huge files including 4K movies and games.\*

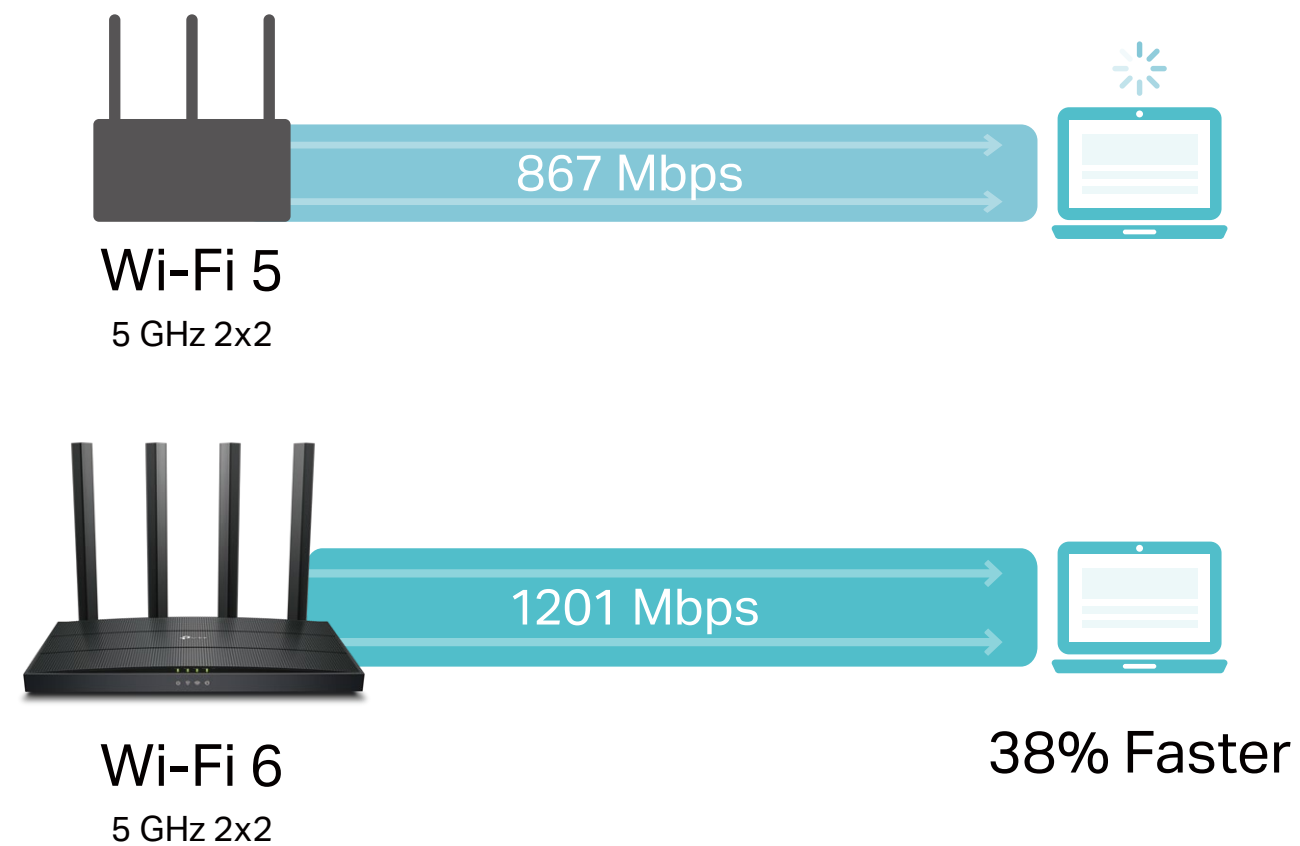

## Gigabit Internet Access

Take full advantage of your broadband with speed up to 1 Gbps with a Gigabit WAN port. Plug your PCs, smart TVs and game consoles into one of the three Gigabit LAN ports for fast and reliable wired connections.△

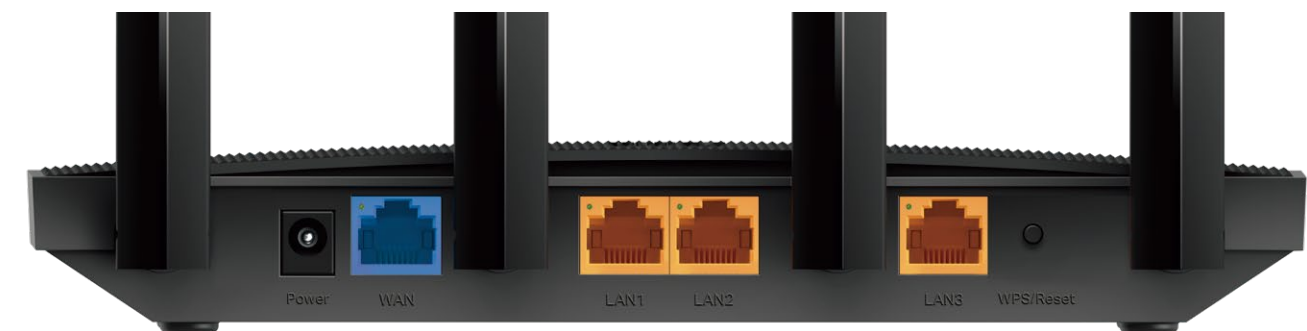

Gigabit Ports

# Highlights

## Convenient Mesh Networking\*

Mesh networking creates smooth, fast, stable roaming. Archer AX18 can build an EasyMesh network with devices that use EasyMesh technology. Eliminate Wi-Fi dead zones, expand your network, and fill your entire home with high-speed Wi-Fi.

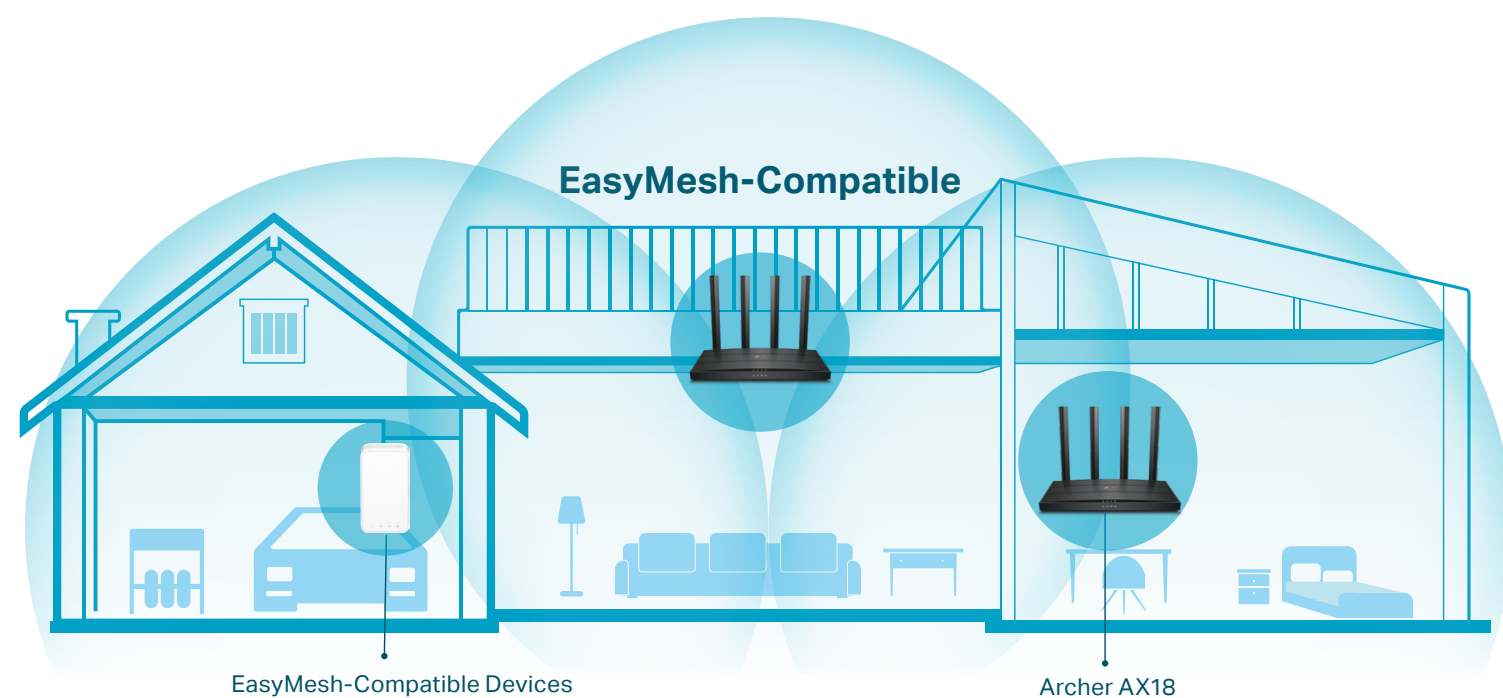

## Easy Setup and Use

Installation is simple, thanks to an intuitive web interface and the powerful TP-Link app, Tether. Tether lets you manage your network settings with your smartphone.



Scan the QR code to download TP-Link Tether.

# Features



## Speed

- **AX Tech** – 802.11ax (also known as Wi-Fi 6) features advanced technologies including OFDMA and 1024QAM, drastically increasing the speed and efficiency of the entire network
- **Ultimate Wireless Speed** – 300 Mbps on 2.4 GHz (802.11n) + 1201 Mbps on 5 GHz (802.11ax)
- **Gigabit Internet Access** – Take full advantages of broadband speeds up to 1 Gbps<sup>^</sup>

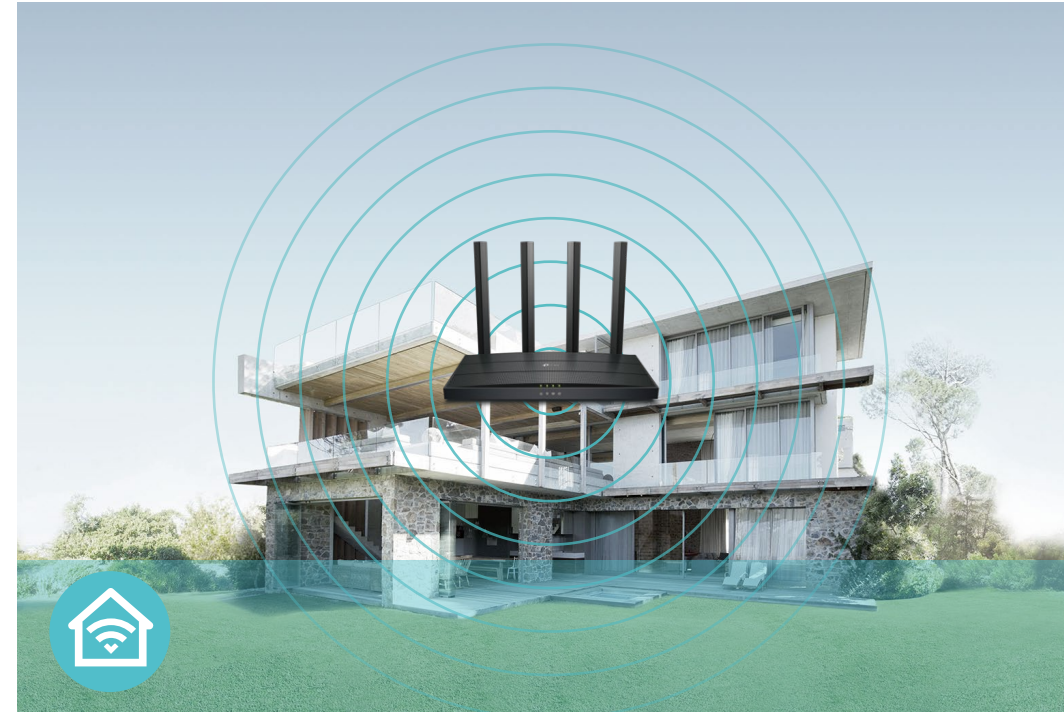

## Wi-Fi Range

- **Ultimate Range Wi-Fi** – Four external antennas deliver a Wi-Fi signal to every corner of your home, making all of your connections more efficient and stable
- **Beamforming Technology** – Concentrates Wi-Fi signals towards individual devices to ensure stronger connections
- **Seamless EasyMesh Network** – Transfer between signals without any drops or lag and manage your whole network using a centralized panel



## Reliability

- **VPN Support** – Safely reach files in local NAS, wherever you are
- **Airtime Fairness** – Equally divides network time between new devices, such as your gaming rig and older devices to improve your overall Wi-Fi performance and reliability
- **Quality of Service** – Prioritizes devices for optimum performance when needed

# Features

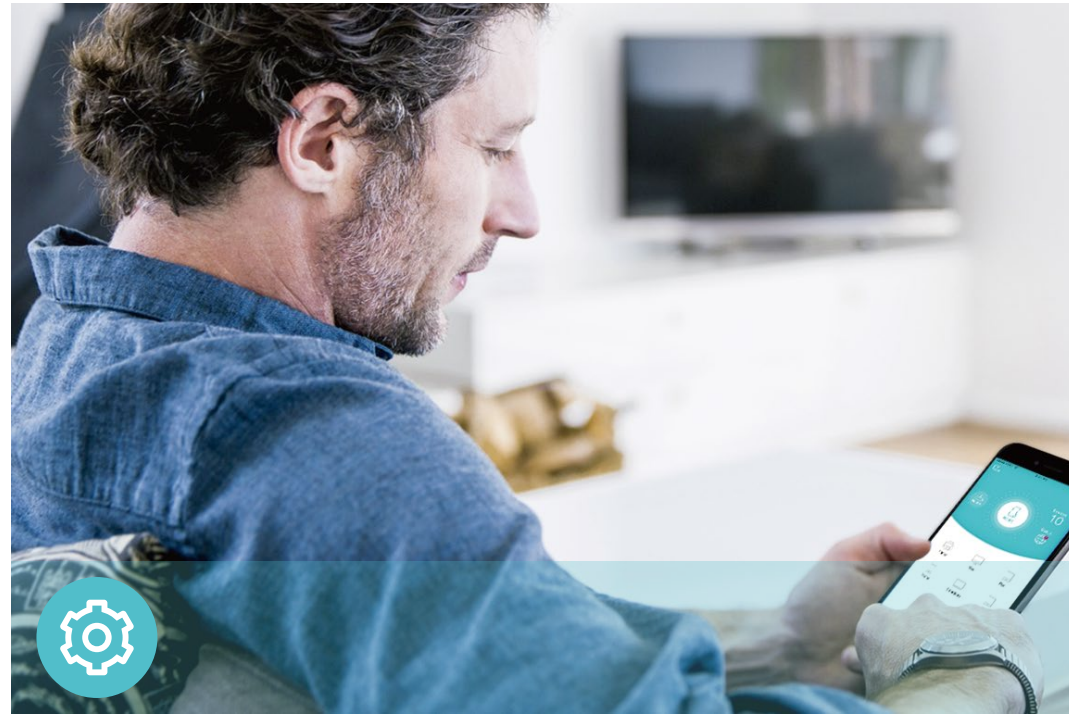

## Ease of Use

- Intuitive Web UI – Ensures quick and simple Installation without hassle
- Fast Encryption – One-touch WPA wireless security encryption with the WPS button
- Hassle-free Management with Tether App – Network management is made easy with the TP-Link Tether App, available on any Android and iOS device



## Security

- Guest Network – Provides separate access for guests while securing the home network
- Access Control – Establishes a whitelist or blacklist to allow or restrict certain devices to access the internet
- Parental Controls – Manage when and how devices can access the internet
- WPA3 Security – The latest Wi-Fi security protocol, WPA3, brings new capabilities to improve cybersecurity. More secure encryption in Wi-Fi password safety and enhanced protection against brute-force attacks combine to safeguard your home Wi-Fi.†

# Specifications

## Hardware

- Ethernet Ports: 1× Gigabit WAN Port + 3× Gigabit LAN Ports
- Buttons: WPS/Reset Button
- Antennas: Four External Antennas
- External Power Supply: 12V/1A
- Dimensions (W x D x H): 8.5 × 4.6 × 1.3 in(215 × 117 × 32mm)

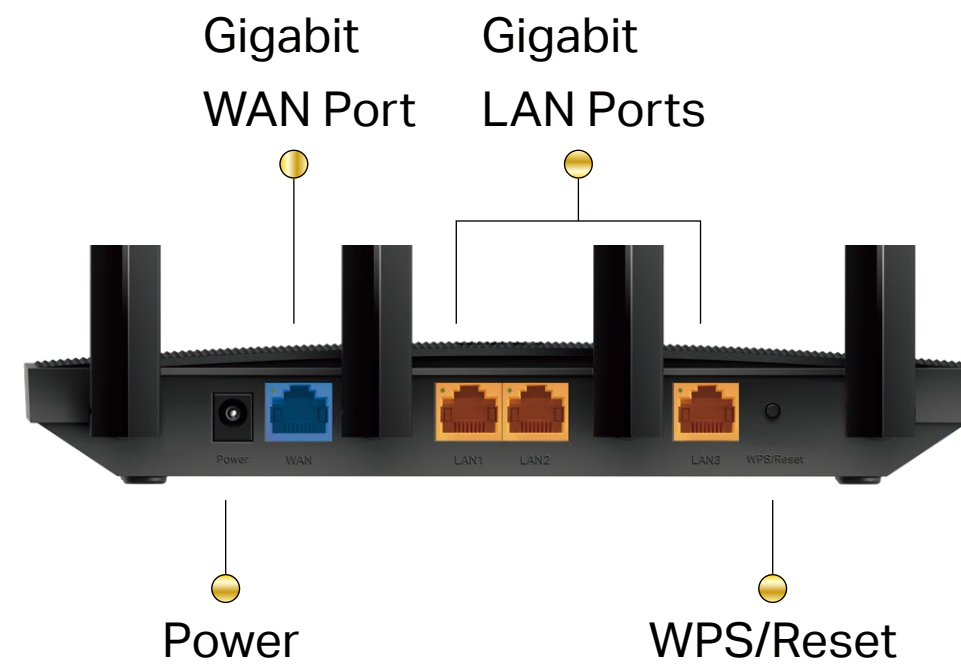

## Wireless

- Wireless: 1201 Mbps (5 GHz, 11ax) + 300 Mbps (2.4 GHz, 11n), compatible with 11a/b/g/n/ac/ax Wi-Fi standards
- Frequency: 2.4 GHz and 5 GHz
- Transmit Power:  
CE: <20dBm(2.4 GHz), <23dBm(5.15 GHz~5.25 GHz)
- Reception Sensitivity:  
5 GHz:  
11a 6Mbps:-95dBm, 11a 54Mbps:-79dBm  
11ac VHT20\_MCS0:-96dBm, 11ac VHT20\_MCS8:-66dBm  
11ac VHT40\_MCS0:-94dBm, 11ac VHT40\_MCS9:-63dBm  
11ac VHT80\_MCS0:-91dBm, 11ac VHT80\_MCS9:-60dBm  
11ax HE20\_MCS0:-95dBm, 11ax HE20\_MCS11:-66dBm  
11ax HE40\_MCS0:-92dBm, 11ax HE40\_MCS11:-65dBm  
11ax HE80\_MCS0:-89dBm, 11ax HE80\_MCS11:-62dBm  
2.4 GHz:  
11g 6Mbps: -96 54Mbps: -80  
HT20-MCS0: -97 MCS7: -78  
HT40-MCS0: -94 MCS7: -75
- Wireless Function: Enable/Disable Wireless Radio, WMM
- Wireless Security: WPA2-PSK, WPA2-PSK/WPA-PSK, WPA3-Personal, WPA3-Personal/WPA2-PSK, WPA2-Enterprise, WPA/WPA2-Enterprise encryptions

# Specifications

## Software

- Protocols: IPv4, IPv6
- EasyMesh: Supported
- Parental Controls
- WAN Types: Dynamic IP, Static IP, PPPoE, PPTP, L2TP
- Quality of Service: QoS by Device
- Cloud Service: Auto Firmware Upgrade, TP-Link ID, DDNS
- NAT Forwarding: Port Forwarding, Port Triggering, DMZ, UPnP
- DDNS: TP-Link, NO-IP, DynDNS

## Others

- Certification:  
CE, RoHS
- System Requirements:  
Edge, Firefox, Chrome, Safari, or other JavaScript-enabled browser  
\*You are recommended to use the latest version  
Cable or DSL Modem  
Subscription with an internet service provider (for internet access)
- Environment:  
Operating Temperature: 0°C~40°C (32°F ~104°F)  
Storage Temperature: -40°C~60°C (-40°F ~140°F)  
Operating Humidity: 10%~90% non-condensing  
Storage Humidity: 5%~90% non-condensing
- Package Contents  
Wireless Router Archer AX18  
Power Adapter  
RJ45 Ethernet Cable  
Quick Installation Guide



For more information, please visit

[https://www.tp-link.com/products/details/?model=Archer+AX18\\_V1](https://www.tp-link.com/products/details/?model=Archer+AX18_V1)

or scan the QR code left

Specifications are subject to change without notice. TP-Link is a registered trademark of TP-Link Corporation Limited. Other brands and product names are trademarks or registered trademarks of their respective holders. Copyright ©2023 TP-Link Corporation Limited. All rights reserved.

<sup>1</sup>Maximum wireless signal rates are the physical rates derived from IEEE Standard 802.11 specifications. Actual wireless data throughput, wireless coverage and number of connected devices are not guaranteed and will vary as a result of network conditions, client limitations, and environmental factors, including building materials, obstacles, volume and density of traffic, and client location.

<sup>2</sup>Use of 802.11ax (Wi-Fi 6), and features including WPA3, OFDMA and 1024-QAM requires clients to also support corresponding features.

<sup>3</sup>The 802.11ax white paper defines standardized modifications to both the IEEE 802.11 physical layers (PHY) and the IEEE 802.11 Medium Access Control (MAC) layer as enabling at least one mode of operation capable of supporting improvement of at least four times the average throughput per station (measured at the MAC data service access point) in a dense deployment scenario.

<sup>4</sup>1,000 Mbps internet speeds require compatible service plans and equipment. Actual network speed may be limited by the rate of the product's Ethernet WAN or LAN port, the rate supported by the network cable, Internet service provider factors and other environmental conditions.

<sup>5</sup>30% less download time is a result of the 38% improvement in speed from Wi-Fi 5 5 GHz 2×2 to Wi-Fi 6 5 GHz 2×2.

<sup>6</sup>TP-Link EasyMesh-compatible products can network with other devices that use EasyMesh. Failed connections may be due to firmware conflicts of different vendors. The EasyMesh-Compatible function is still being developed on some models and will be supported in subsequent software updates.

<sup>7</sup>Further software upgrades for feature availability may be required.