

Quick Start Guide

Solar-Powered Security Camera KIT

*Images may differ from actual products.
7106510954 REV1.0.0 ©2024 TP-Link

Camera Status LED Indication

Blinking amber quickly for 3 seconds	Plugging in USB charger
Solid red	Starting up
Blinking red and green	Ready for setup
Blinking red slowly	Connecting to Wi-Fi
Solid amber	Connected to Wi-Fi
Solid green	Connected to the cloud
Blinking red quickly	Camera resetting
Blinking green quickly	Camera updating

1 Charge the Battery

The battery comes partially charged. We recommend that you fully charge the battery before use. This will take about **five and a half** hours.

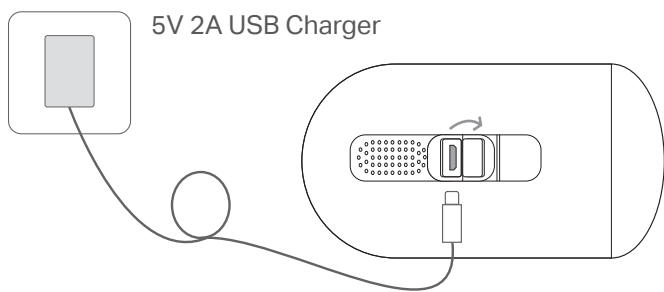

Note:

1. Peel off film from the camera before use.
2. Charge the battery using the USB cable in the package. Inappropriate cables may result in slow charging or failure to charge.
3. Warning: Do not tear off the silicone part by force as it may affect the waterproof performance.
4. When you plug in the USB charger, the LED should blink amber quickly for 3 seconds. If not, make sure the power is running and check your connection.
5. Keep the ports firmly covered when not in use to ensure waterproof performance.
6. Check the battery status on the Tapo app after setup.

2 Set Up the Camera

1. Get the Tapo app from the App Store or Google Play.



2. Press and hold on your camera for about 3 seconds to turn it on. Open the Tapo app, tap the button in the app, and select your model. Then follow the app instructions to set up your camera.

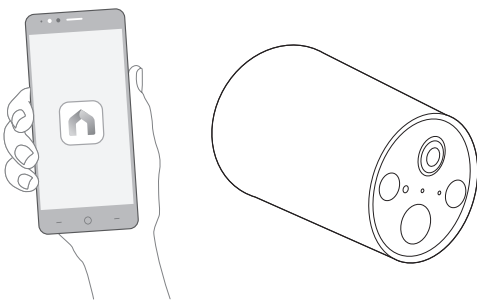

3 Camera Mounting Tips

1. Avoid placing behind glass. Glass will obstruct the motion sensor of your camera.
2. Choose a proper location to mount your camera, or it will be triggered too often by false alarms.
 - Avoid pointing the camera directly at swaying trees.
 - Avoid pointing the camera directly at vehicles and pedestrians on the road.
 - Avoid pointing the camera directly at street lamps and sunlight.
3. Mount your camera to the side so that movement goes across the lens' field of view to better trigger motion detection and AI detection.

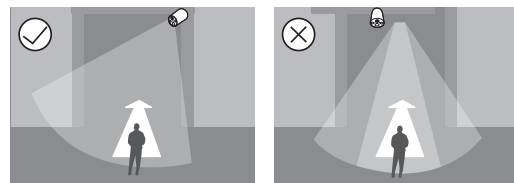

*Do not mount facing the direction of movement.

4. Do not place the camera upside down.
5. Keep the motion sensor level for best results.

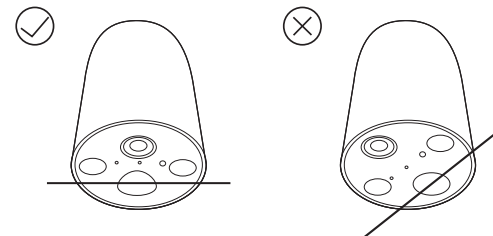

6. Tilt the camera downwards at an angle of about 15°.

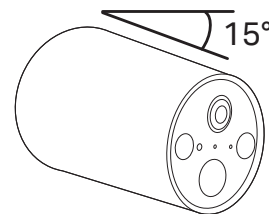

4 Solar Panel Mounting Tips

The position and tilt angle of the solar panel greatly affects the solar efficiency.

1. Choose a location where the solar panel gets the most sunlight throughout the year.
2. Position the panel south-facing in the Northern Hemisphere or north-facing in the Southern Hemisphere. The recommended tilt angle between the panel and the horizontal ground is 35° ~ 45°.
3. Regularly wipe the panel to remove dust and debris.

Appearance

Front

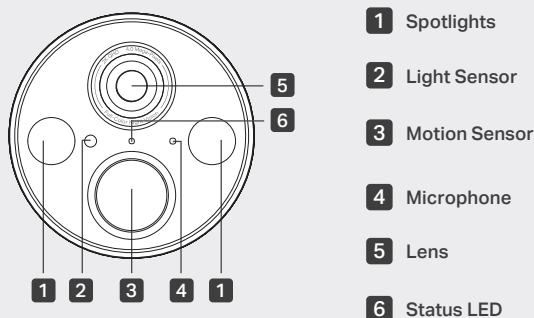

Side

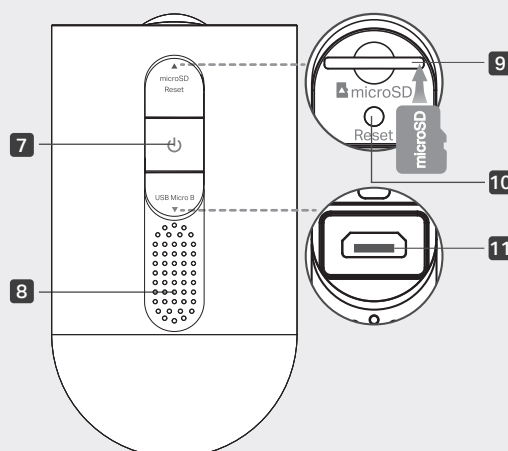

- 7 **Power Button** Press and hold for about 3 seconds to turn on/off the camera.
- 8 **Speaker**
- 9 **microSD Card Slot** Open the cover. Insert a microSD card* and initialize it on the Tapo app for local recording. *microSD card not included.
- 10 **Reset Button** Open the cover. Use a pin to press and hold for at least 5 seconds to reset the camera to factory default settings.
- 11 **USB Micro B Charging Port** Open the cover for USB charging.

5 Mount Solar Panel & Camera

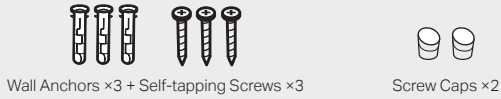
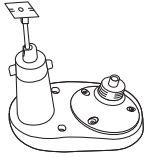

1. Drill Holes

Stick the mounting template to a solid and level wall surface. Drill three screw holes according to the template.

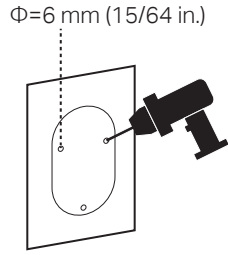

2. Mount Bracket

Insert three wall anchors into the holes and use the mounting screws to affix the solar panel bracket over the anchors. Then, insert two screw caps into the upper screw holes.

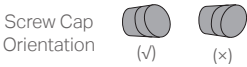
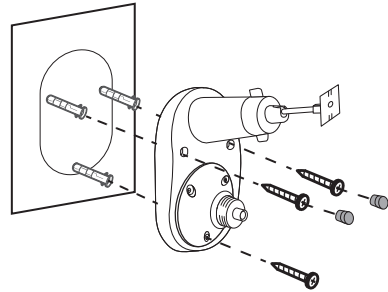

3. Install the Solar Panel

Slide the solar panel onto the mounting bracket until it clicks into place.

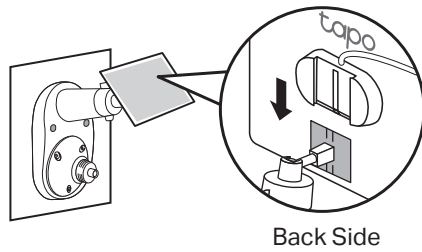

4. Adjust Solar Panel Angle

Loosen the adjustable screw, tilt the solar panel to adjust the angle, and then tighten the adjustable screw.

The recommended tilt angle between the panel and the horizontal ground is 35° ~ 45°.

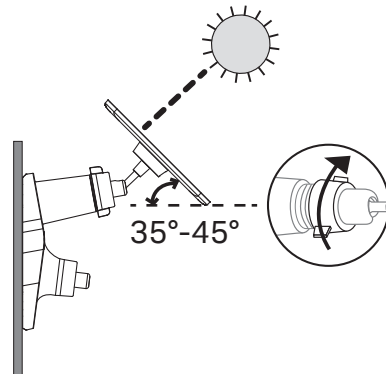

5. Install Camera & Adjust Angle

Install the camera onto the bracket and tilt the camera downwards at an angle of about 15°.

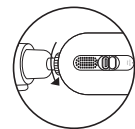

Ensure the camera is securely attached to the camera bracket by tightening the bottom screw.

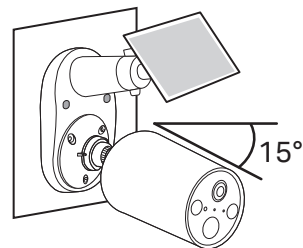

6 Connect to the Camera

Use the appropriate waterproof gasket when connecting the solar panel to your camera. The gasket protects your camera from exposed moisture and dust that may damage the camera.

1. Install Waterproof Gasket

Insert the waterproof gasket into the camera's charging port. Ensure that the gasket is tightly sealed.

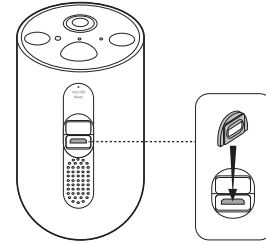

2. Power On Camera

Connect the solar panel by inserting the connector with the black ring into the USB adapter until snug. Then connect the USB adapter to the charging port of your camera.

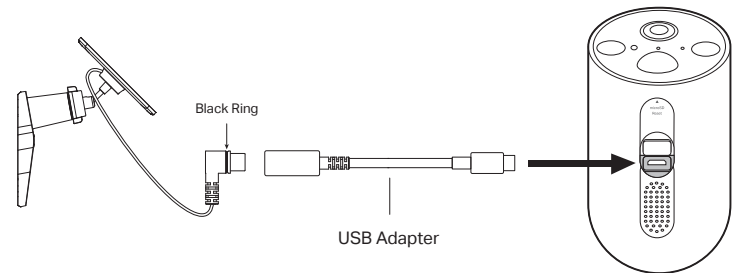

If the power cable is too short...

Extend the power cable using the provided extension cable. Insert the connector with the black ring into the extension until snug and use the appropriate gasket when connecting the solar panel to your camera.

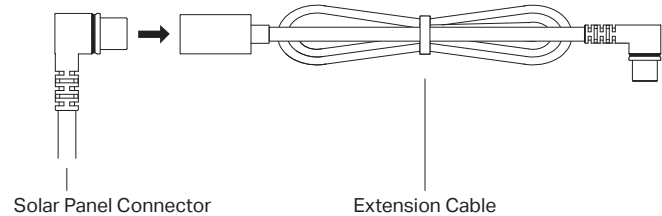

If the power cable is too long...

Use the cable zip tie provided to bundle up the excess cable. Once tightened, the zip tie cannot be easily adjusted. To release the tie, you will need to cut the zip tie.

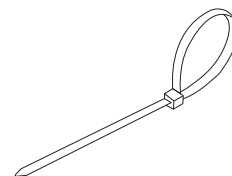

Safety Information

For Solar Panel:

- Keep the device away from fire or hot environments. DO NOT immerse in water or any other liquid.
- Do not attempt to disassemble, repair, or modify the device. If you need service, please contact us.

TP-Link hereby declares that the device is in compliance with the essential requirements and other relevant provisions of directives 2014/30/EU, 2014/35/EU, 2011/65/EU and (EU)2015/863.

The original EU declaration of conformity may be found at <https://www.tapo.com/en/support/ce/>

TP-Link hereby declares that the device is in compliance with the essential requirements and other relevant provisions of the Electromagnetic Compatibility Regulations 2016 and Electrical Equipment (Safety) Regulations 2016.

The original UK declaration of conformity may be found at <https://www.tapo.com/support/ukca/>

For Camera:

- Do not use damaged charger or USB cable to charge the device.
- Do not use any other chargers than those recommended.
- Do not use the device where wireless devices are not allowed.
- Adapter shall be easily accessible.
- Use only power supplies which are provided by manufacturer and in the original packing of this product. If you have any questions, please don't hesitate to contact us.
- Keep the device away from fire or hot environments. DO NOT immerse in water or any other liquid.
- Do not disassemble, repair or modify the product.
- Do not place near automatically controlled devices such as fire alarms. Radio waves emitted from this product may cause such devices to malfunction resulting in an accident.
- Observe restrictions on using wireless products in fuel depots, chemical plants or when blasting operations are in progress.
- Do not use liquid to clean the product. Only use a dry cloth.
- Never put metal objects inside the product. If a metal object enters the product turn off the circuit breaker and contact an authorised electrician.
- This product is not intended to be used when providing medical care. Consult the manufacturer of any personal medical devices, such as pacemakers or hearing aids to determine if they are adequately shielded from external RF (radio frequency) energy.
- Do not use this product in health care facilities. Hospitals or health care facilities may be using equipment that could be sensitive to external RF energy.

Support

For technical support, the user guide, FAQs, warranty and more, please visit <https://www.tapo.com/support/>



- Do not place heavy objects on top of the product.
- When you leave the product unused for a long time unplug the product from the power outlet.
- This product may interfere with other electronic products such as TV, radios, personal computers, phones or other wireless devices.
- Operating Temperature: -20°C ~ 45°C (-4°F ~ 113°F)
- When mounting the camera with the magnetic base, we recommend installing it no higher than 2 meters.
- Adapter should be used indoors where the ambient temperature is lower than or equal to 40°C.

CAUTION!

Avoid replacement of a battery with an incorrect type that can defeat a safeguard. Avoid disposal of a battery into fire or a hot oven, or mechanically crushing or cutting of a battery, that can result in an explosion. Do not leave a battery in an extremely high temperature surrounding environment that can result in an explosion or the leakage of flammable liquid or gas; Do not leave a battery subjected to extremely low air pressure that may result in an explosion or the leakage of flammable liquid or gas.

Please read and follow the above safety information when operating the device. We cannot guarantee that no accidents or damage will occur due to improper use of the device. Please use this product with care and operate at your own risk.

TP-Link hereby declares that the device is in compliance with the essential requirements and other relevant provisions of directives 2014/53/EU, 2009/125/EC, 2011/65/EU and (EU)2015/863.

The original EU declaration of conformity may be found at <https://www.tapo.com/support/ce/>

TP-Link hereby declares that the device is in compliance with the essential requirements and other relevant provisions of the Radio Equipment Regulations 2017.

The original UK declaration of conformity may be found at <https://www.tapo.com/support/ukca/>

