



User Guide

Smart Motion Sensor

Contents

About This Guide	1
Introduction	2
Tapo Smart Ecosystem	3
Automate Your Home	4
Set Up Your Smart Sensor	5
Use Your Smart Sensor	7
Explore Smart Actions	9
How to Replace the Battery	11
How to Reset Your Smart Sensor	12
Authentication	13

About This Guide

This guide provides a brief introduction to the Smart Motion Sensor and the Tapo app, as well as regulatory information.

Please note that features available in Tapo may vary by model and software version. Tapo availability may also vary by region. All images, steps, and descriptions in this guide are only examples and may not reflect your actual Tapo experience.

Conventions

In this guide, the following convention is used:

Convention	Description
Blue	Key information appears in blue, including management page text such as menus, items, buttons and so on.
<u>Underline</u>	Hyperlinks are in blue and underlined. You can click to redirect to a website.

More Info

- Specifications can be found on the product page at <https://www.tapo.com>.
- Our Technical Support and troubleshooting information can be found at <https://www.tapo.com/support/>.
- The setup videos can be found at <https://www.tp-link.com/support/setup-video/#smart-sensors>.

Introduction

The Motion Sensor detects movement in a certain area and triggers different actions in response. This makes your home safer and smarter.

- **Motion Detection**– Captures motion in your home with customization..
- **Works with Tapo Devices** – Controls other Tapo smart devices based on your movement.
- **Instant Alerts & App Notification** – Triggers alarm to warn unwanted visitors and sends you notifications.
- **Adjustable Sensitivity** – Tailor your detection coverage with 3 levels. Captures motion up to 23 ft.(7m) away.
- **Flexible Sensor Angle** – Rotate the sensor with 120° view to avoid accidental activations.
- **Battery-Powered** – Compact battery supports two years of use. No wiring required.
- **Easy Installation** – Mount it by attached 3M adhesive or the build-in magnet.
- **Device Sharing** – Easily share management permissions with each member of your family.
- **Hub Required** – The Tapo Hub is required to support smart features.

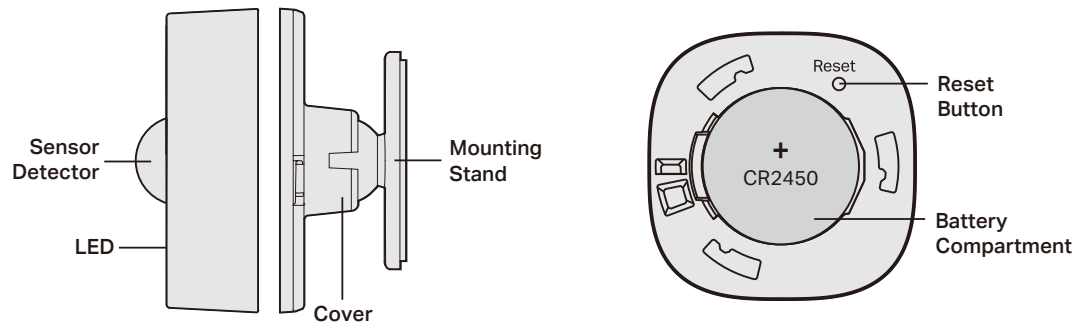

Tapo Smart Ecosystem

Tapo is the easy way to turn your home into a smart home. With the Tapo Hub as a bridge, Tapo Smart Sensor works with a wide range of Tapo accessories. So you can easily control and monitor your home from anywhere.



Automate Your Home

Create a Smart Action to automate your smart devices and activate them all with motion. Customize your own Smart Actions to group your Tapo products together any way you want.



Tapo T100



Tapo Hub



Build Smart Alarm

Trigger alarm to frighten away unwanted visitors and send you notifications via Tapo app when motion is detected.



Tapo T100



Smart Lighting



OR

Set Automatic Lighting

The smart light turns on as people come and go, then turn off automatically after 2 minutes.

Set Up Your Smart Sensor

▶ Watch setup videos at <https://www.tp-link.com/support/download/tapo-t100/>

Before You Start

A Tapo Hub is required. Make sure your Tapo Hub is successfully added via the Tapo app.



OR



1. Set Up Your Sensor

Tap the ⊕ button in the Tapo app, tap **Sensors**, and select your model. Follow the instructions in the Tapo app to complete the setup.

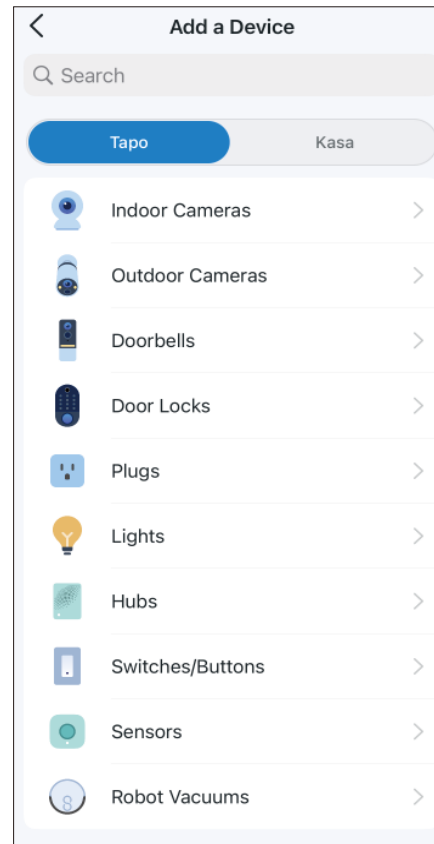

2. Check the LED & Set Up

Check if the LED blinks. If not, use a pin to press and hold the Reset button for 5s. Follow app instructions to complete the setup.

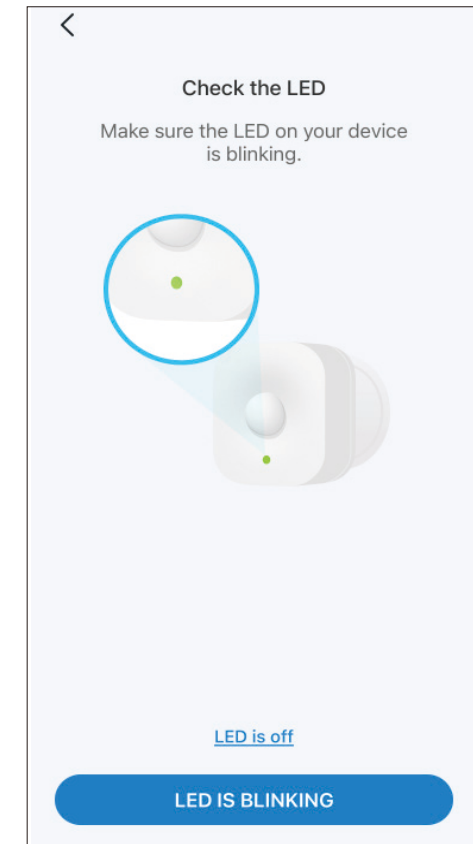

3. Test Your Sensor

Take your sensor to the preferred location and wave your hand in front of the sensor to test it. The Tapo app should show if the sensor is triggered.



4. Place Your Sensor

Option 1:
Magnetically attach to
metallic objects

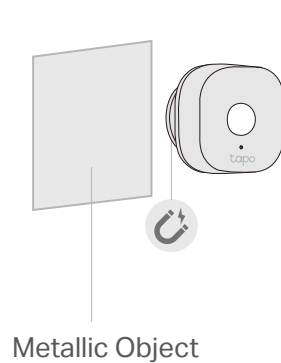

OR

Option 2:
Stick to a clean wall
with included adhesive

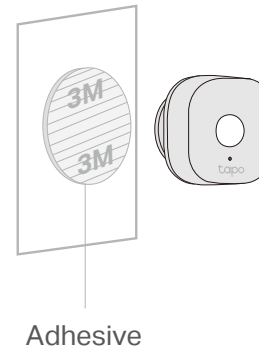

OR

Option 3:
Place it on a shelf or
table

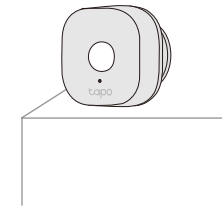

Detection Area

The sensor should be aligned with the detection area and placed as close as possible to the edge of a table or cabinet. The installation height should not be higher than 2 meters.

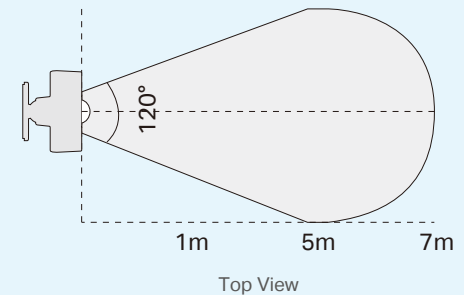
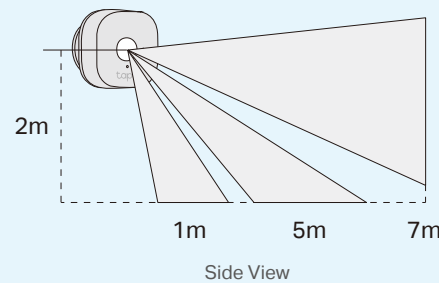

Use Your Smart Sensor

After you successfully set up your hub and motion sensor, you will see your devices listed on the home page. With the Tapo app, you can view and manage your devices and get instant notifications anytime, anywhere.

Home Page

This page lists all the devices you've added and you can view them directly and manage them easily. Tap the card to enter its [Status](#) page.

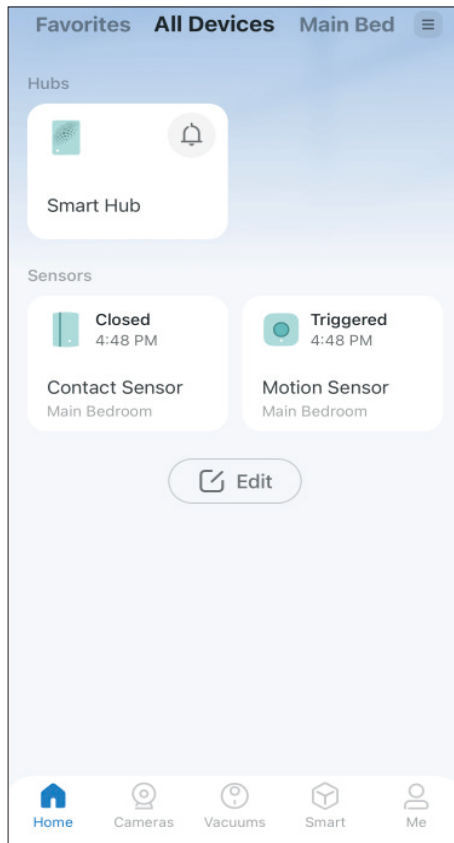

Home Page Settings

Long press on a card, then you can reorder cards, tap  to remove your device from your account, share your device, favorite/unfavorite device, or relocate your device to other Home.

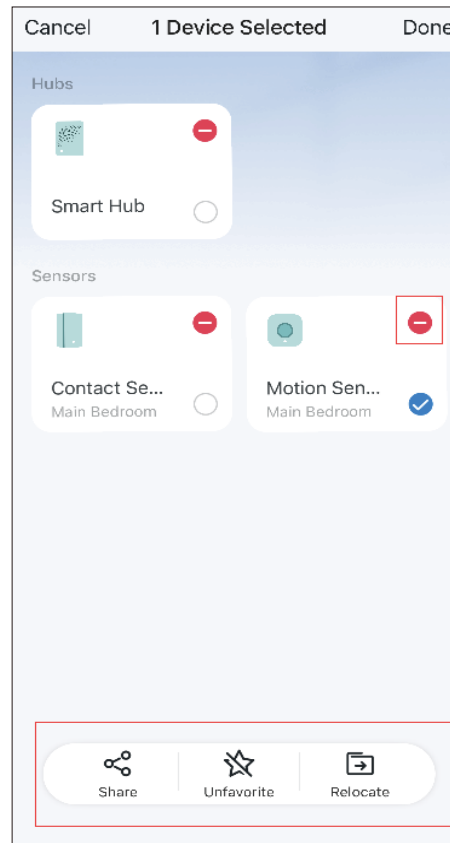

Status Page

You can check all events of you sensor. Slide the panel up to check more settings or tap the gear icon to enter the [Settings](#) page.

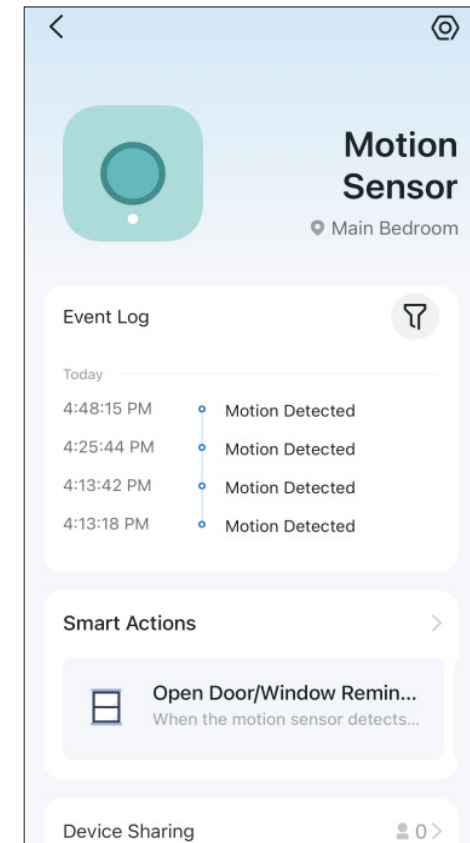

Smart Actions

The sensor can work with other Tapo devices to automate your home. You can customize smart actions based on the templates.

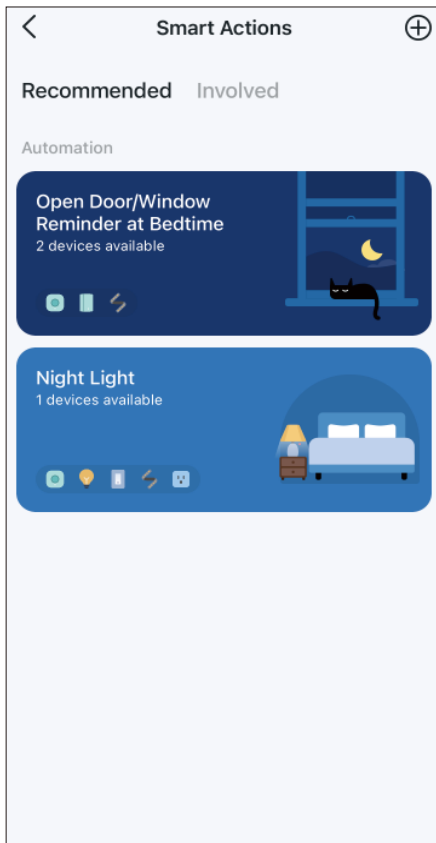

Device Settings

Check/edit the basic info, set Notifications settings, view User Manual and Placement Guide, or remove your device from your account.

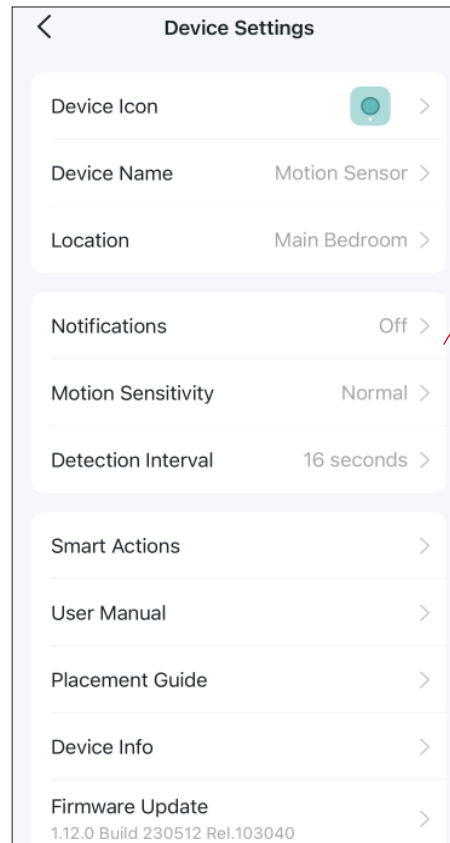

Notifications Settings

Turn on Notifications if you want to receive app notifications when your sensor detects an event. Set the time you want to be notified.

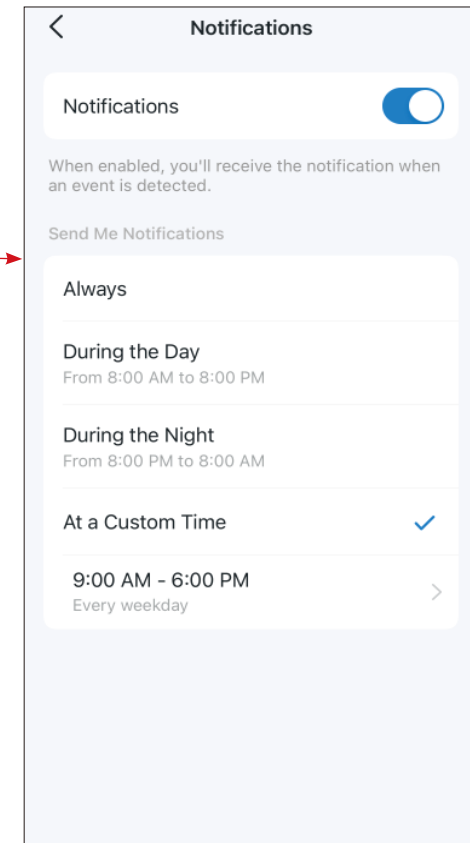

Explore Smart Actions

The sensor can work with other Tapo devices to automate your home. It detects movement in a certain area and triggers different actions in response. You can customize smart actions based on the templates. This makes your home safer and smarter.

Option 1: Edit based on the featured actions

1. Go to the [Smart Actions](#) page and you will see the [Featured Actions](#) (Shortcut or Automation).

2. Tap on a featured action. Select the devices and set the time as needed and tap [ADD](#) to save changes.

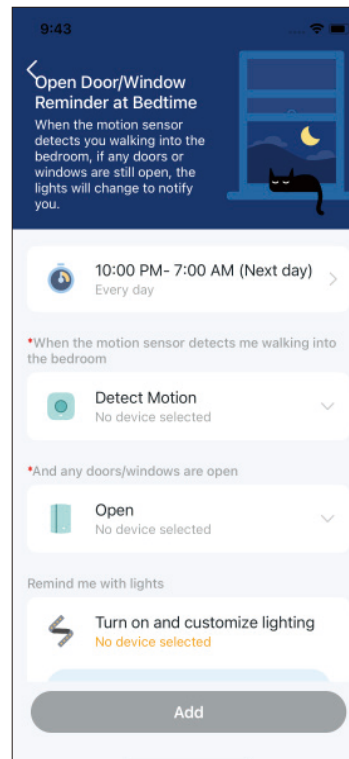
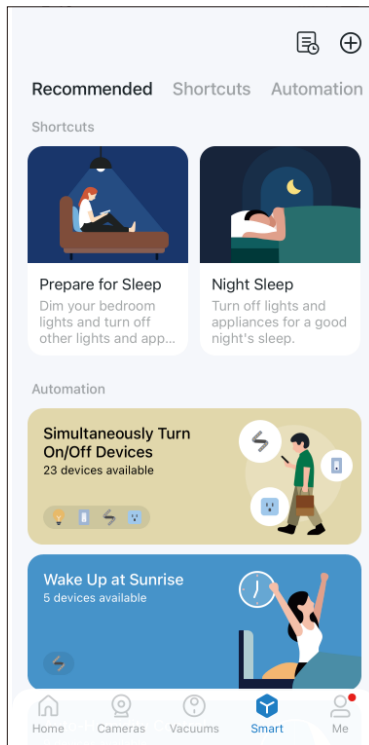

Option 2: Create your own actions

1. Go to **Smart** page. Tap **+** on the top right to add a simple and smart action.

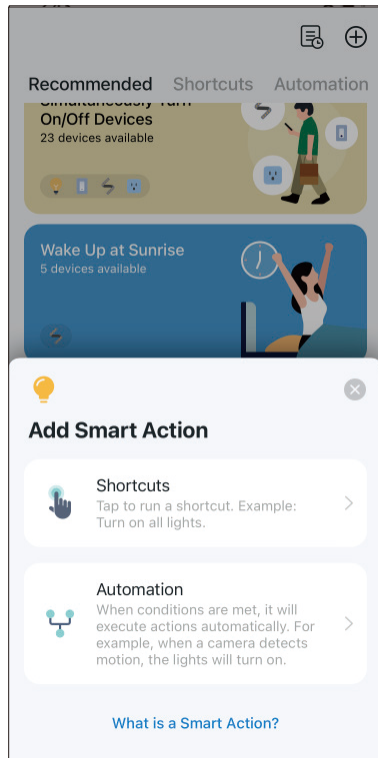

2. For Shortcuts: Tap **+** to add action like turning on the smart plug.

For Automation: Tap **+** to add triggers (**When**) like the trigger time, tap **+** to add conditions (**If**) like when the bedroom light is on, and tap **+** to add actions (**Then**) like turning on the smart light plug.

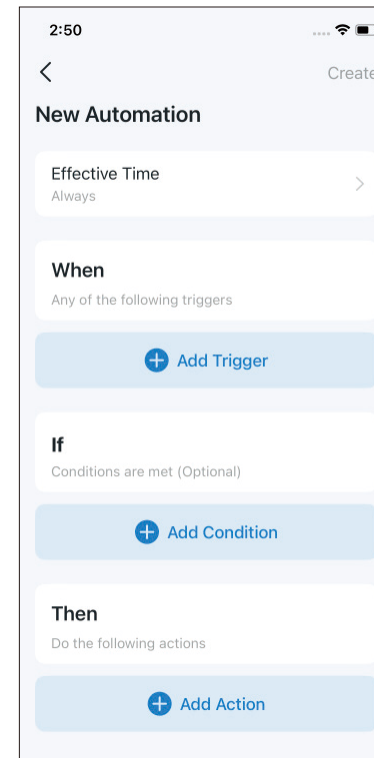
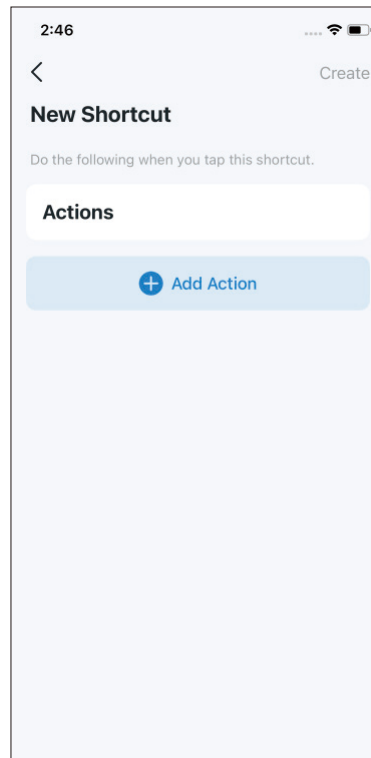

How to Replace the Battery

▶ Watch videos at <https://www.tp-link.com/support/download/tapo-t100/>

If your device is mounted on the wall with 3M adhesive, please remove the main body from the mounting bracket first.

1. Remove the mounting stand from the cover.
2. Insert the shim or use your fingernail to lift the clip.
3. Twist the cover anticlockwise to remove it.
4. Remove the old battery. Insert the new battery into the battery compartment, making sure the battery is level and its positive side is facing up.

Option 1: With a Shim

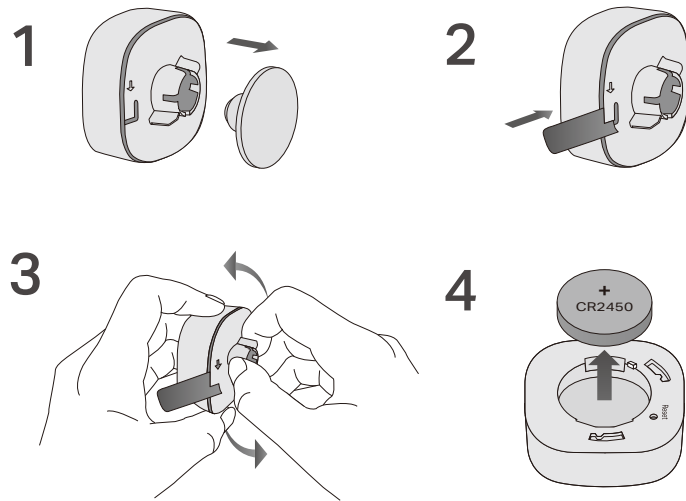

OR

Option 2: By Hand

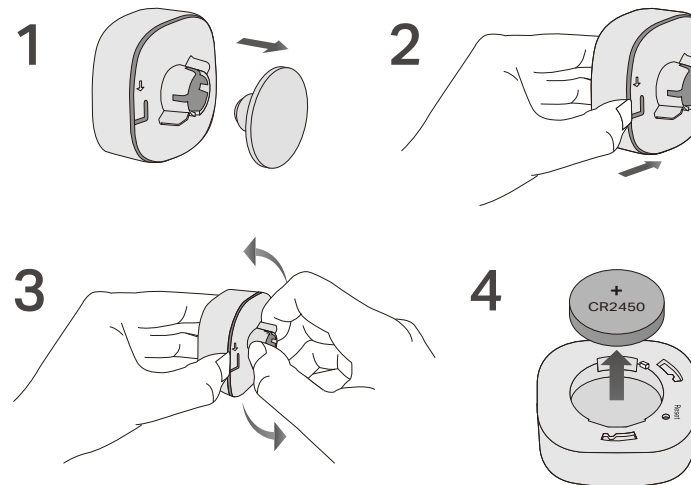

How to Reset Your Smart Sensor

▶ Watch videos at <https://www.tp-link.com/support/download/tapo-t100/>

Option 1. Via Reset Button

Remove the cover, then use a pin to press and hold the Reset button for 5 seconds until the front LED starts blinking.

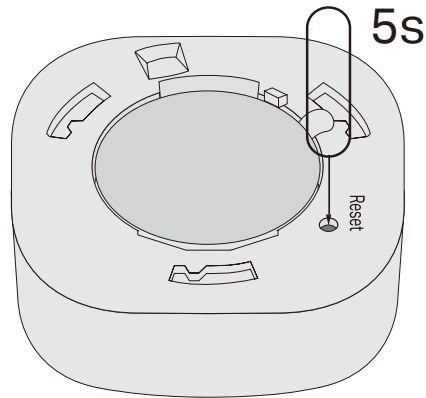

Option 2. Via the Tapo App

Long press the card on the home page and tap  or go to the [Device Settings](#) page and tap the [Remove](#) button to remove your sensor from your account.

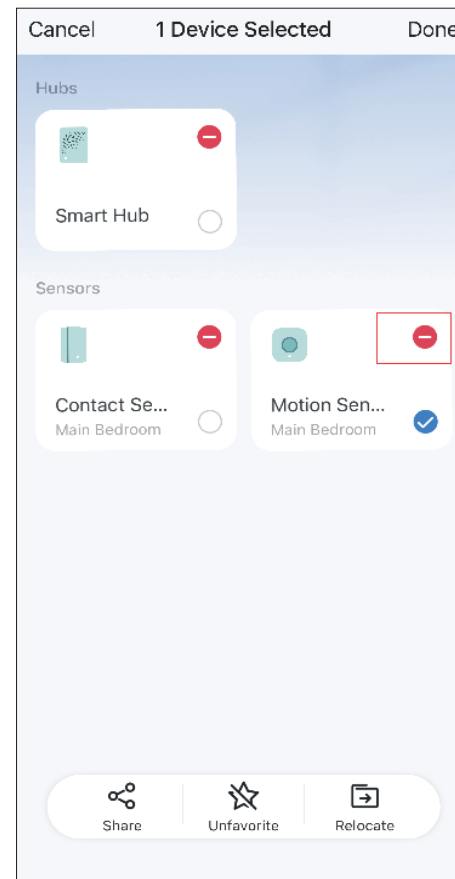

OR

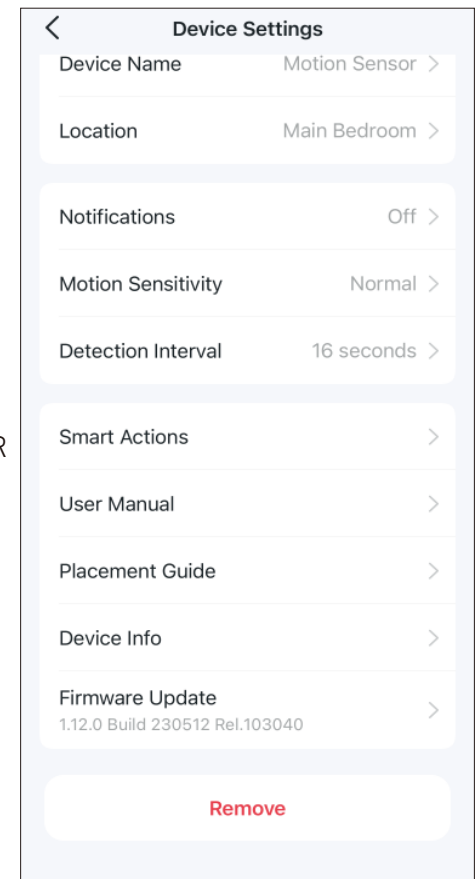

Authentication

FCC Compliance Information Statement



Product Name: Smart Motion Sensor

Model Number: Tapo T100

Responsible party:

TP-Link USA Corporation

Address: 10 Mauchly, Irvine, CA 92618

Website: <http://www.tp-link.com/us/>

Tel: +1 626 333 0234

Fax: +1 909 527 6804

E-mail: sales.usa@tp-link.com

This equipment has been tested and found to comply with the limits for a Class B digital device, pursuant to part 15 of the FCC Rules. These limits are designed to provide reasonable protection against harmful interference in a residential installation. This equipment generates, uses and can radiate radio frequency energy and, if not installed and used in accordance with the instructions, may cause harmful interference to radio communications. However, there is no guarantee that interference will not occur in a particular installation. If this equipment does cause harmful interference to radio or television reception, which can be determined by turning the equipment off and on, the user is encouraged to try to correct the interference by one or more of the following measures:

- Reorient or relocate the receiving antenna.
- Increase the separation between the equipment and receiver.
- Connect the equipment into an outlet on a circuit different from that to which the receiver is connected.
- Consult the dealer or an experienced radio/ TV technician for help.

This device complies with part 15 of the FCC Rules. Operation is subject to the following two conditions:

1. This device may not cause harmful interference.
2. This device must accept any interference received, including interference that may cause undesired operation.

Any changes or modifications not expressly approved by the party responsible for compliance could void the user's authority to operate the equipment.

Note: The manufacturer is not responsible for any radio or TV interference caused by unauthorized modifications to this equipment. Such modifications could void the user's authority to operate the equipment.

FCC RF Radiation Exposure Statement

This equipment complies with FCC RF radiation exposure limits set forth for an uncontrolled environment. This device and its antenna must not be co-located or operating in conjunction with any other antenna or transmitter.

"To comply with FCC RF exposure compliance requirements, this grant is applicable to only Mobile Configurations. The antennas used for this transmitter must be installed to provide a separation distance of at least 20 cm from all persons and must not be co-located or operating in conjunction with any other antenna or transmitter."

We, **TP-Link USA Corporation**, has determined that the equipment shown as above has been shown to comply with the applicable technical standards, FCC part 15. There is no unauthorized change is made in the equipment and the equipment is properly maintained and operated.

Issue Date: 2024-07-23

CE Mark Warning



This is a class B product. In a domestic environment, this product may cause radio interference, in which case the user may be required to take adequate measures.

Operating Frequency / Nominal Operating Frequency / Max Output Power:

863~865MHz / 863.35MHz / 25mW (e.r.p)

863~865MHz / 864.35MHz / 25mW (e.r.p)

868~868.6MHz / 868.35MHz / 25mW (e.r.p)

EU declaration of conformity

TP-Link hereby declares that the device is in compliance with the essential requirements and other relevant provisions of directives 2014/53/EU, 2011 /65/EU and (EU) 2015/863.

The original EU declaration of conformity may be found at <https://www.tapo.com/en/support/ce/>

RF Exposure Information

This device meets the EU requirements (2014/53/EU Article 3.1a) on the limitation of exposure of the general public to electromagnetic fields by way of health protection.

The device complies with RF specifications when the device used at 20 cm from your body.

Restricted to indoor use.

UKCA Mark



UK Declaration of Conformity

TP-Link hereby declares that the device is in compliance with the essential requirements and other relevant provisions of the Radio Equipment Regulations 2017.

The original UK declaration of conformity may be found at <https://www.tapo.com/support/ukca/>

Korea Warning Statements:

당해 무선설비는 운용중 전파혼신 가능성이 있음.

NCC Notice

注意!

取得審驗證明之低功率射頻器材，非經核准，公司、商號或使用者均不得擅自變更頻率、加大功率或變更原設計之特性及功能。

低功率射頻器材之使用不得影響飛航安全及干擾合法通信；經發現有干擾現象時，應立即停用，並改善至無干擾時方得繼續使用。

前述合法通信，指依電信管理法規定作業之無線電通信。

低功率射頻器材須忍受合法通信或工業、科學及醫療用電波輻射性電機設備之干擾。



Продукт сертифіковано згідно с правилами системи УкрСЕПРО на відповідність вимогам нормативних документів та вимогам, що передбачені чинними законодавчими актами України.

Safety Information

- Keep the device away from water, fire, humidity or hot environments.
- Do not attempt to disassemble, repair, or modify the device. If you need service, please contact us.
- Do not use the device where wireless devices are not allowed.
- Please read and follow the above safety information when operating the device. We cannot guarantee that no accidents or damage will occur due to improper use of the device. Please use this product with care and operate at your own risk.
- Do not ingest battery, Chemical Burn Hazard

CAUTION!

Risk of explosion if the battery is replaced by an incorrect type

CAUTION!

Avoid replacement of a battery with an incorrect type that can defeat a safeguard.

Avoid disposal of a battery into fire or a hot oven, or mechanically crushing or cutting of a battery, that can result in an explosion.

Do not leave a battery in an extremely high temperature surrounding environment that can result in an explosion or the leakage of flammable liquid or gas. Do not leave a battery subjected to extremely low air pressure that may result in an explosion or the leakage of flammable liquid or gas.

CAUTION: Do not ingest battery. Chemical Burn Hazard

- This product contains a coin / button cell battery. If the coin / button cell battery is swallowed, it can cause severe internal burns in just 2 hours and can lead to death.
- Keep new and used batteries away from children.
- If the battery compartment does not close securely, stop using the product and keep it away from children.
- If you think batteries might have been swallowed or placed inside any part of the body, seek immediate medical attention

Warnings

Operating Temperature: 0 °C– 40 °C (32°F–104°F)

Operating Humidity: 10%–90%RH, Non-condensing

Handling Instructions for Lithium Ion Rechargeable Battery

Please read and follow the handling instructions for the battery before use. Improper use of the battery may cause heat, fire explosion, damage or capacity deterioration of the battery.

- Do not place or leave the battery and equipment in the reach of infants so that they are not able to swallow or mistreat the battery by mistake.

In case of ingestion, consult with a doctor immediately.

- Do not let leaked electrolyte come into contact with eyes or skin.

In such a case, immediately wash the area of contact with clean water and seek help from a doctor.

If not treated soon, prolonged contact may cause serious injury.

- Do not put the battery into a fire. Do not use it or leave it in a place near fire, heaters, or high temperature sources.

In such a case, the insulator in the battery may be melted, the safety vent and structure may be damaged, or the electrolyte may catch fire, all of which may cause heat generation, explosion, or fire.

- Do not submerge the battery in water, or wet the battery.

If the protecting device assembled in the battery is damaged, the battery may be charged with an abnormal current and voltage and may cause a chemical reaction within the battery, which may result in the cause of heat generation, explosion, or fire of the battery.

- Do not use any battery charger not specified by the manufacture, also follow the charge conditions specified by the manufacture.

If the battery is charged under other conditions (a high temperature, a high voltage / current, or an altered charger) not specified by the manufacture, the battery may become over-charged with an excessive current and cause heat, explosion, or fire with abnormal chemical reactions.

- Do not use, charge, or leave the battery near fire or in a car under the blazing sun. Such a high temperature may cause damage of the protecting device in the battery, which may result in an abnormal reaction, and then heat generation, explosion, or fire.

- Do not connect the battery reversed in positive (+) and negative (-) terminals in the charger or equipment.

In case the battery is connected and charged reversely, it may cause heat generation, explosion, or fire due to an abnormal chemical reaction.

- Do not let the battery terminals (+ and -) contact a wire or any metal (like a metal necklace or a hairpin) with which it carried or stored together.

In such a case, the battery will be shorted and cause an excessive current, which may result in heat generation, explosion, or fire.

- Do not connect the battery directly to an electric outlet or cigarette heater socket in car.

With a high voltage applied, the battery may overheat, explode, or cause fire.

- Do not throw or drop the battery.

Strong impact may damage the protecting device, which may cause an abnormal chemical reaction during charging and result in heat generation, explosion, or fire of the battery.

- Do not drive a nail in, hit with a hammer, or stamp on the battery.

In such a case, the battery may be deformed and shorted, which may cause heat generation, explosion, or fire of the battery.

- Do not solder the battery directly.

Heat applied during soldering may damage the insulator of the safety vent and mechanism, which may result in heat generation, explosion, or fire of the battery.

- Do not disassemble or alter the battery.

The battery employs a safety mechanism and a protecting device in order to avoid any danger.

If these are damaged, heat, explosion or fire may be caused.

CAUTION

- Do not put the battery in a microwave or a pressure cooker.

Sudden heat may damage the seal of the battery and may cause heat generation, explosion, or fire of the battery.

- Do not use the battery with other maker's batteries, different types and / or models of batteries such as dry batteries, nickel-metal hydride batteries, or nickel-cadmium batteries, or new and old lithium ion batteries together.

In such a case, over-discharge during use, or over-charge during charge may occur abnormal chemical reactions and may cause heat generation, explosion, or fire of the battery.

- Do not leave the battery in a charger or equipment if it generates an odor and /or heat, changes color and / or shape, leaks electrolyte, or causes any other abnormality.

In such a case, immediately take the battery out of the charge or equipment and keep it away from fire, otherwise, the battery might overheat, explode, or cause fire.

- Discontinue charging after specified charging time even if the charge is not complete, otherwise, the battery might cause heat generation, explosion, or fire.

- Do not use the battery in the place where the static electricity (more than the limit of the manufacturer's guarantee) occurs. Otherwise, the protecting device in the battery might be damaged and cause heat generation, explosion, or fire.

- Do not use the battery in other than the following conditions; otherwise, the battery might cause heat generation, damage, or deterioration of its performance.

Operating environment:

When the battery is charged: 0°C ~ +45°C (Humidity < 80%)

When stored 1 months: -20°C ~ +50°C (Humidity < 80%)







When stored 3 months: -20°C ~ +45°C (Humidity < 80%)













When stored 1 year: -20°C ~ +20°C (Humidity < 80%)





Please read and follow the above safety information when operating the device. We cannot guarantee that no accidents or damage will occur due to improper use of the device. Please use this product with care and operate at your own risk.

Explanation of the symbols on the product label

Symbols may vary from products

Symbol	Explanation
	Class II equipment
	Class II equipment with functional earthing
	Alternating current
	DC voltage
	Polarity of output terminals
	Indoor use only
	Dangerous voltage

Symbol	Explanation
	Caution, risk of electric shock
	Energy efficiency Marking
	Protective earth
	Earth
	Frame or chassis
	Functional earthing
	Caution, hot surface
	Caution
	Operator's manual
	Stand-by
	"ON"/"OFF" (push-push)
	Fuse

Symbol	Explanation
	Fuse is used in neutral N
	<p>RECYCLING</p> <p>This product bears the selective sorting symbol for Waste electrical and electronic equipment (WEEE). This means that this product must be handled pursuant to European directive 2012/19/EU in order to be recycled or dismantled to minimize its impact on the environment.</p> <p>User has the choice to give his product to a competent recycling organization or to the retailer when he buys a new electrical or electronic equipment.</p>
	Caution, avoid listening at high volume levels for long periods
	Disconnection, all power plugs
m	Switch of mini-gap construction
μ	<p>Switch of micro-gap construction (for US version)</p> <p>Switch of micro-gap / micro-disconnection construction (for other versions except US)</p>
ε	Switch without contact gap (Semiconductor switching device)