

Grandstream Networks, Inc.

126 Brookline Ave, 3rd Floor
Boston, MA 02215. USA
Tel : +1 (617) 566 - 9300

www.grandstream.com



BE	BG	CZ	DK	DE	EE	IE	EL	LI
ES	FR	HR	IT	CY	LV	LT	LU	CH
HU	MT	NL	AT	PL	PT	RO	SI	TR
SK	FI	SE	NO	IS	UK	UK(NI)		

In the UK and EU member states, operation of 5150-5350 MHz is restricted to indoor use only.



For Certification, Warranty and RMA information, please visit
www.grandstream.com

GHP620/W GHP621/W Compact Hotel Phone

Quick Installation Guide

* The content in this guide refers to the GHP62x/W series with hardware version V5.0 or higher.

Content

English.....	1
简体中文.....	6
Español.....	9
Français.....	14
Deutsch.....	19
Italiano.....	24
Русский.....	29
Português.....	32
Regulatory Information.....	36

EN

The GHP620/W and GHP621/W are not pre-configured to support or carry emergency calls to any type of hospital, law enforcement agency, medical care unit (“Emergency Service(s)”), or any other kind of Emergency Service. You must make additional arrangements to access Emergency Services. It is your responsibility to purchase SIP-compliant Internet telephone service, properly configure the GHP620/W and GHP621/W to use that service, and periodically test your configuration to confirm that it works as you expect. If you do not do so, it is your responsibility to purchase traditional wireless or landline telephone services to access Emergency Services.

GRANDSTREAM DOES NOT PROVIDE CONNECTIONS TO EMERGENCY SERVICES VIA THE GHP620/W AND GHP621/W. NEITHER GRANDSTREAM NOR ITS OFFICERS, EMPLOYEES OR AFFILIATES MAY BE HELD LIABLE FOR ANY CLAIM, DAMAGE, OR LOSS. YOU HEREBY WAIVE ANY AND ALL SUCH CLAIMS OR CAUSES OF ACTION ARISING FROM OR RELATING TO YOUR INABILITY TO USE THE GHP620/W AND GHP621/W TO CONTACT EMERGENCY SERVICES, AND YOUR FAILURE TO MAKE ADDITIONAL ARRANGEMENTS TO ACCESS EMERGENCY SERVICES IN ACCORDANCE WITH THE IMMEDIATELY PRECEDING PARAGRAPH.

The GNU GPL license terms are incorporated into the device firmware and can be accessed via the Web user interface of the device at [http\(s\)://IP/#/gpl_license](http(s)://IP/#/gpl_license). To obtain a CD with GPL source code information, please submit a written request to info@grandstream.com

PRECAUTIONS:

WARNING: Please DO NOT power cycle the GHP620/W and GHP621/W during system bootup or firmware upgrade. You may corrupt firmware image files and cause the unit to malfunction.

WARNING: Use only the power adapter included in the GHP620/W/ GHP621W package. Using an alternative nonqualified power adapter may damage the unit.

OVERVIEW:

The GHP series of hotel phones feature the GHP620(W) and GHP621(W), easy-to-use IP phones for any hotel rooms that can be programmed and customized based on the needs of hotels and their guests. The GHP620W and GHP621W models are equipped with integrated dual-band Wi-Fi. The features of GHP series include HD speaker, 2 SIP accounts/lines, 6 programmable keys, 10 speed dial keys, 3-way voice conferencing, full band Opus voice codec, and advanced jitter-resilience algorithm that tolerates up to 30% packet loss without impacting voice quality. The GHP series is supported by Grandstream Device Management System (GDMS), which provides a centralized interface to configure, provision, manage and monitor the deployment of Grandstream endpoints. The GHP series IP phones can be installed on desktop or wall-mounted, and can be powered by PoE and power adapter. Its elegant and compact design makes it perfect for not only hotels, but also hospitals, apartments, dormitories and much more.

PACKAGE CONTENT:

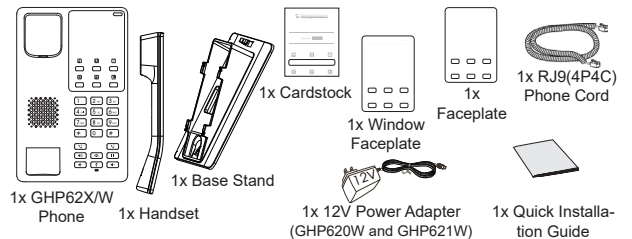

GHP620/W & GHP621/W DESCRIPTION:

Front panel

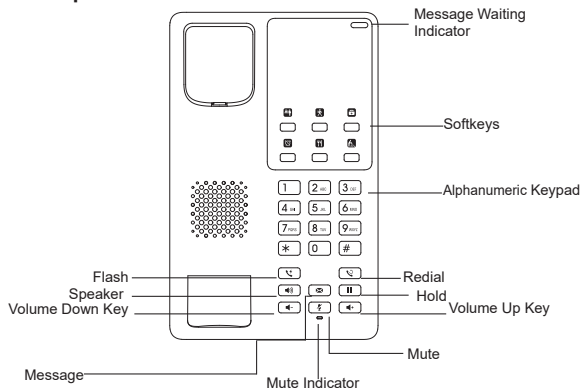

Note: The LED for the message waiting indicator will flash in green when there is a message waiting.

Back panel

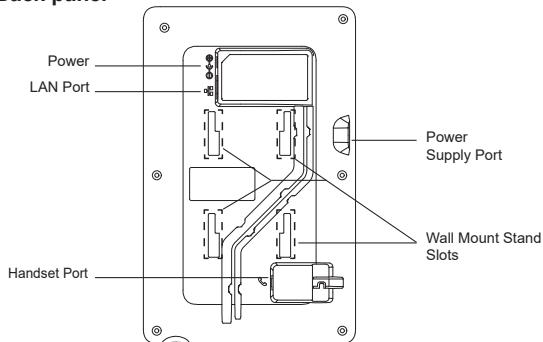

PHONE SETUP:

Wall Mount

1. On the wall where the GHP620/W & GHP621/W will be mounted, mark two dots with 100mm distance in between vertically.
2. Using a drill, make a hole on each marked dot. Put a plastic expansion bolt and screw (not provided) into each hole. Leave enough space on the screws to mount the GHP620/W & GHP621/W.
3. Attach the wall mount spacers on the slot for wall mount spacers on the back of the phone.
4. Mount the GHP620/W & GHP621/W on the screws using its "Wall Mount Slots".

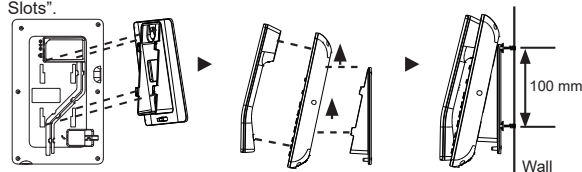

Desktop Installation

For installing the phone on the table with the phone stand, attach the phone stand to the bottom of the phone where there is a slot for the phone stand.

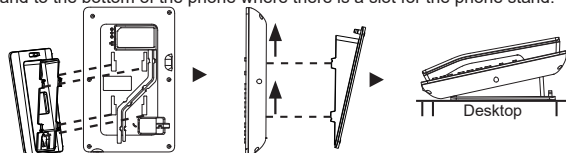

INSTALLING THE FACEPLATE:

1. Put the customized paper card into the deep groove of the phone surface shell and fix it.
2. Remove the release paper from the back of the faceplate.
3. Stick the faceplate on the indicated area. Please refer to the illustration on the right.

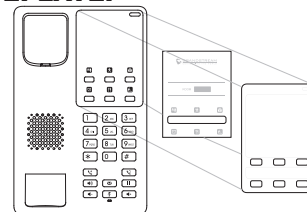

CONNECTING THE PHONE:

To set up the phone, follow the steps below:

1. Plug in the phone cord to the handset RJ9 port and then connect it to the base.
2. Connect the LAN port of the phone to the RJ45 socket of a hub/switch or a router (LAN side of the router) using the Ethernet cable. This step can be skipped if using GHP620W & GHP621W with Wi-Fi.
3. Power up the phone:
 - **Option 1:** Connect the 12V DC output plug to the power jack on the phone; plug the power adapter into an electrical outlet.
 - **Option 2:** A PoE switch must be used in step 2.

Note: The GHP620W/GHP621W is preconfigured to connect to a default SSID named **"wp_master"** with password (WPA/WPA2 PSK) **"wp1987@dmn"**. Users can also modify these settings from the phone's web UI.

PHONE CONFIGURATION:

1. Ensure your phone is powered up and connected to the Internet.
2. Locate the MAC address on the bottom of the device or on the package.
3. From a computer connected to the same network as the GHP62X, type in the following address using the GHP62X's MAC address on your browser: **https://<mac>.local**
Example: https://c074adffff.local
Note: The user can also dial ****47#** and the current IP address will be announced by the IVR.
4. Enter the admin username and password to access the configuration menu. (The factory default username is "admin" and the default random password can be found on the sticker at the back of the unit).

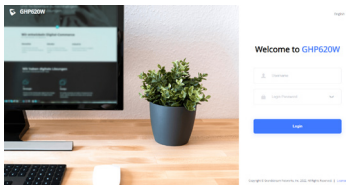

Refer to online documents and FAQ for more detailed information: <https://www.grandstream.com/our-products>

GHP620/W和GHP621W不预设对医院，执法机构，医疗中心(急救服务)以及各种紧急服务的紧急通话服务。用户必须自行设定紧急通话功能。用户必须自行购买SIP兼容的网络电话服务，正确地设定GHP620/W和GHP621/W使用该服务，并定期测试您的配置以确保GHP620/W和GHP621/W如预期工作，否则请购买传统无线或有线电话服务来拨打紧急通话。

Grandstream Networks 公司的GHP620/W和GHP621/W不支持紧急通话服务。Grandstream Networks 公司、其管理者和员工以及其相关机构对此所造成的任何索赔、损失或者损害都不负有任何法律追究责任。在此，您将无权对任何以及所有由于无法通过GHP620/W和GHP621/W拨打紧急电话以及没有遵照前段文字描述而造成紧急通话失败的事件提出诉讼。

GNU GPL许可条款已包含在设备固件中，可以通过设备的Web用户界面进行访问：[http\(s\)://IP/#/gpl_license](http(s)://IP/#/gpl_license)。如果需要包含GPL源代码信息的CD，请发邮件到 info@grandstream.com 提交请求。

注意事项:

警告: 请不要在设备启动未完成或设备升级软件的过程中断开电源, 因为该操作会导致话机本身的程序损坏, 进而导致设备无法启动。

警告: 请使用设备包装中的电源, 因为使用其他没有经过认证的替代电源适配器有可能对设备造成损害。

产品概览:

GHP系列酒店电话包括GHP620/W和GHP621/W, 是一款紧凑型IP电话, 适用于任何酒店客房, 并可以根据酒店及客人的需求实现编程化和定制化。GHP620W 和 GHP621W 型号设备集成双频Wi-Fi。GHP系列具有高清扬声器、2个SIP账号/线路、6个可编程按键、10个快速拨号键、3方语音会议、全频段Opus语音编解码器和先进的防抖算法, 在不影响语音质量情况下可承受高达30%的数据包丢失。GHP系列支持使用Grandstream的设备管理系统(GDMS) 来提供集中式管理和云监控部署。GHP系列IP电话可安装在桌面或墙壁上, 通过PoE和电源适配器供电。其优雅精致的设计使它不仅适用于酒店, 也适用于医院、公寓、宿舍等更多场景。

设备包装清单:

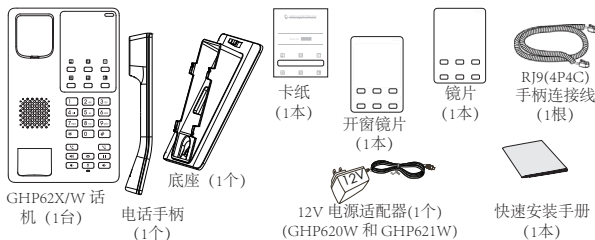

产品概览:

前置面板

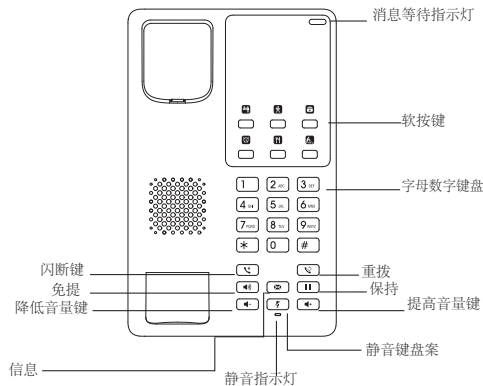

注意: 当有消息等待时, 消息等待指示灯的LED将以绿色闪烁。

安装面板:

1. 请将定制卡纸放入话机外壳深层凹槽处并固定它。
2. 从面板背面取下防粘纸。
3. 将面板贴在指定区域。请参考右图。

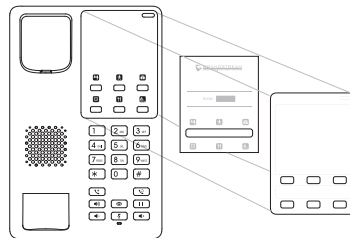

更多有关详细信息, 请参阅在线文档和常见问题解答
<https://www.grandstream.com/our-products>

El teléfono GHP620/W / GHP621/W no viene pre configurado ni tiene acceso a información de ningún tipo de servicio de llamadas de emergencia, hospitales, servicios policiales, unidades de cuidados médicos o cualquier otro tipo de servicio de socorro. Usted deberá hacer las coordinaciones necesarias para poder acceder a estos servicios. Será su responsabilidad, el contratar el servicio de telefonía por internet compatible con el protocolo SIP, configurar apropiadamente el teléfono GHP620/W / GHP621/W para usar dicho servicio y periódicamente, probar su configuración para confirmar su funcionamiento de acuerdo a sus expectativas. Si usted decide no hacerlo, será su responsabilidad comprar servicios de telefonía tradicional, ya sea por línea fija o inalámbrica para poder acceder a los servicios de emergencia.

GRANDSTREAM NO PROVEE CONEXIONES CON NINGUN SERVICIO DE EMERGENCIA MEDIANTE EL GHP620/W / GHP621/W. NI GRANDSTREAM NI SUS DIRECTORES, EMPLEADOS O AFILIADOS, PUEDEN SER SUJETOS RESPONSABLES POR NINGUN RECLAMO, DAÑO O PERDIDA. POR LO TANTO, POR LA MEDIANTE, USTED RENUNCIA A SU DERECHO DE RECLAMO O DENUNCIA QUE PUEDA SURGIR DEBIDO A LAS LIMITACIONES EN EL USO DEL GHP620/W / GHP621/W PARA CONTACTAR A LOS SERVICIOS DE EMERGENCIA, ASI COMO A SU NEGLIGENCIA DE REALIZAR LAS COORDINACIONES NECESARIAS PARA ACCEDER A TODOS LOS SERVICIOS DE EMERGENCIA, MENCIONADOS EL PARRAFO PRECEDENTE.

Los términos de licencia GNU GPL son incorporados en el firmware del dispositivo y puede ser accedido a través de la interfaz de usuario Web del dispositivo en [http\(s\)://IP/#/gpl_license](http(s)://IP/#/gpl_license).

Para obtener un CD con la información del código fuente GPL, por favor, remita una solicitud escrita a info@grandstream.com

PRECAUCIONES:

CUIDADO: Por favor NO apague el GHP62X durante el arranque o durante la actualización del firmware. La interrupción de la actualización del firmware puede causar mal funcionamiento del equipo.

CUIDADO: Use solamente el adaptador de corriente incluido con el GHP620W/GHP621W. Usar uno alternativo puede dañar el equipo.

INFORMACIÓN GENERAL:

La serie GHP de teléfonos para hoteles cuenta con los modelos GHP620(W) y GHP621(W), teléfonos IP fáciles de usar para cualquier habitación de hotel que pueden programarse y personalizarse en función de las necesidades de los hoteles y sus huéspedes. Los modelos GHP620W y GHP621W están equipados con Wi-Fi de doble banda integrado. Entre las características de la serie GHP; estas incluyen altavoz HD, 2 cuentas/líneas SIP, 6 teclas programables, 10 teclas de marcación rápida, conferencias de voz de 3 vías, y junto al uso del códec de voz Opus y su resistencia al jitter basado en un algoritmo avanzado; estos permiten una tolerancia de hasta un 30% de pérdida de paquetes sin afectar la calidad de la voz. La serie GHP es compatible con el Sistema de Gestión de Dispositivos de Grandstream (GDMS), el cual proporciona una interfaz centralizada para configurar, aprovisionar, gestionar y supervisar las implementaciones de los terminales de Grandstream. Los teléfonos IP de la serie GHP pueden instalarse en el escritorio o en la pared, y pueden ser alimentados por PoE y adaptador de corriente. Su diseño elegante y compacto lo hace perfecto no solo para hoteles, sino también para hospitales, apartamentos, dormitorios y mucho más.

CONTENIDO DEL PAQUETE:

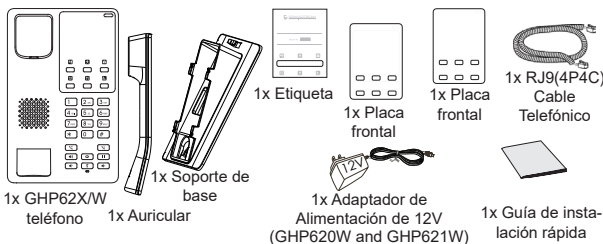

GHP620/W & GHP621/W DESCRIPCIÓN:

Panel frontal

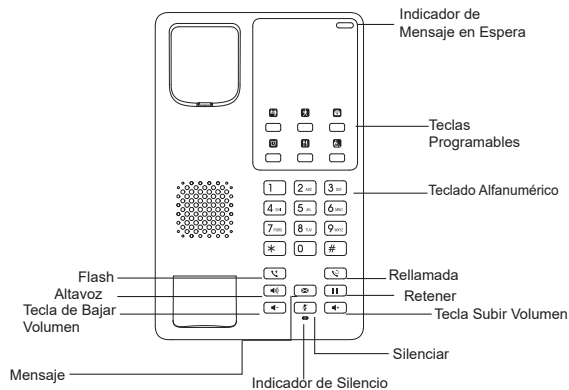

Nota: El LED del indicador de mensaje en espera parpadeará en color verde cuando haya un mensaje en espera.

Panel trasero

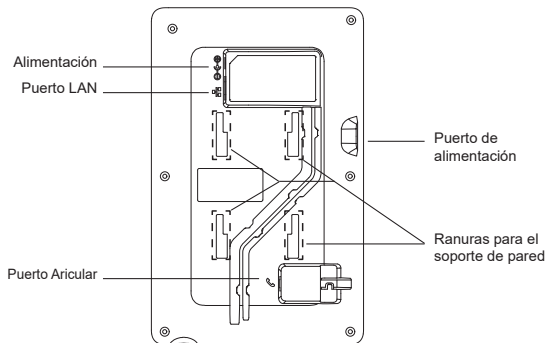

INSTALACIÓN DEL TELEFONO:

Montaje En Pared

1. Marque dos puntos horizontalmente con 100 mm de separación donde colocará la montura de la pared para GHP62X/W
2. Empleando un taladro, perforo cada punto marcado. Coloque tornillos de expansión plásticos en cada uno y atornillelos dejando suficiente espacio para colocar GHP62X/W.
3. Inserte la montura de pared en la ranura de atrás del teléfono.
4. Coloque GHP62X/W en los tornillos utilizando las "ranuras de la montura de pared".

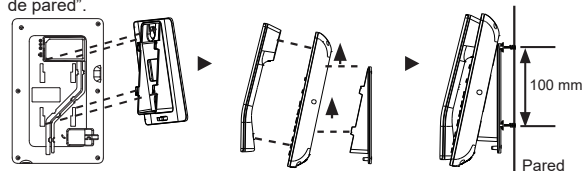

Instalación de escritorio

Para instalar el teléfono sobre un escritorio, utilice el soporte del teléfono y colóquelo en la parte inferior del teléfono donde se encuentra la ranura para el soporte.

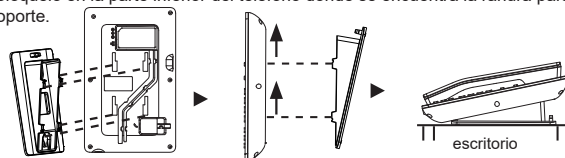

INSTALACIÓN DE LA PLACA FRONTAL:

1. Coloque la tarjeta de papel personalizada en la ranura de la carcasa del teléfono y fíjela.
1. Despegue el papel de protección de la parte posterior de la placa frontal.
2. Pegue la placa frontal en la zona indicada. Refiérase a la ilustración de la derecha.

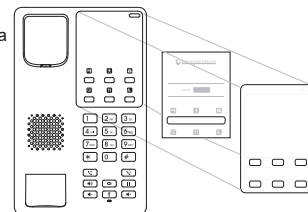

CONECTANDO EL TELÉFONO:

Para configurar el GHP62X/W, siga los pasos detallados abajo:

1. Conecte el auricular (puerto RJ9) y la base con el cable telefónico.
2. Conecte el puerto LAN del teléfono al jack RJ45 de un Hub/switch o router usando el cable Ethernet. puede saltar este paso, si utiliza GHP620W y GHP621W con Wi-Fi.
3. Encendiendo el teléfono:
 - **Opción 1:** Conecte la fuente de poder de 12V DC a la salida de alimentación del teléfono y la salida de electricidad.
 - **Opción 2:** En el paso 2 se debe utilizar un switch PoE.

Nota: Para una fácil implementación, el GHP620W/GHP621W viene preconfigurado para conectarse a un SSID predeterminado llamado **wp_master** con una contraseña (WPA / WPA2 PSK) igual a **wpl987@dmin**, los usuarios pueden adaptar esta configuración desde la interfaz web para Facilitar la implementación en el sitio del cliente.

CONFIGURACIÓN DEL TELÉFONO:

1. Asegure que su teléfono este conectado a la red y tenga electricidad.
2. Ubique la dirección MAC en la etiqueta MAC de la unidad, que se encuentra en la parte inferior del dispositivo o en el paquete.
3. Desde una computadora conectada a la misma red que el GHP620/W / GHP621/W escriba la siguiente dirección usando la dirección MAC del GHP620/W / GHP621/W en su navegador: **https://<mac>.local**

Ejemplo: <https://c074adffffff.local>

Nota: El usuario también puede marcar ****47#**, así la dirección IP será anunciada por el IVR.

4. ngrese como administrador para ver el menú de configuración. (El usuario es "admin" y la contraseña aleatoria debería estar en la etiqueta en la parte trasera de la unidad).

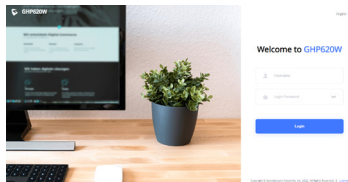

Consulte la documentación en línea y preguntas frecuentes para información mas detallada.
<https://www.grandstream.com/our-products>

FR

Le GHP620/W / GHP621/W n'est pas préconfiguré pour prendre en charge ou acheminer les appels d'urgence adressés aux hôpitaux, organismes chargés de l'application de la loi, centres de soins médicaux (« service(s) d'urgence ») ou tout autre type de service d'urgence. Vous devez prendre des dispositions supplémentaires pour assurer l'accès aux services d'urgence. Il est de votre responsabilité de vous abonner à un service de téléphonie Internet conforme au protocole SIP, de configurer correctement le GHP620/W / GHP621/W pour utiliser ce service, et de tester périodiquement votre configuration pour vous assurer qu'elle fonctionne comme prévu. Si vous ne le faites pas, vous devez vous abonner à un service de téléphonie sans fil ou fixe traditionnel pour accéder aux services d'urgence.

GRANDSTREAM NE FOURNIT PAS DE CONNEXIONS AUX SERVICES D'URGENCE VIA LE GHP620/W / GHP621/W NI GRANDSTREAM, NI SES DIRIGEANTS, EMPLOYES OU SOCIETES AFFILIEES NE PEUVENT ETRE TENUS RESPONSABLES POUR TOUTE RECLAMATION, TOUT DOMMAGE OU PERTE, ET VOUS RENONCEZ PAR LES PRESENTES A TOUTE RECLAMATION OU TOUT MOTIF D'ACTION EN JUSTICE DÉCOULANT OU LIE A VOTRE INCAPACITE D'UTILISER LE GHP620/W / GHP621/W POUR CONTACTER LES SERVICES D'URGENCE, ET TOUTE NEGLIGENCE DE VOTRE PART QUANT A PRENDRE DES DISPOSITIONS SUPPLEMENTAIRES POUR ACCEDER AUX SERVICES D'URGENCE CONFORMÉMENT À L'ALINÉA PRÉCEDENT.

Les termes de la licence GNU GPL sont incorporés dans le micrologiciel du périphérique et sont accessibles via l'interface utilisateur Web du périphérique à l'adresse [http\(s\)://IP/#/gpl_license](http(s)://IP/#/gpl_license). Pour obtenir un CD contenant les informations du code source GPL, veuillez envoyer une demande écrite à info@grandstream.com

PRECAUTIONS:

ALERTE: Veuillez ne pas redémarrer le GHP620/W / GHP621/W lors du démarrage du système ou la mise à jour du firmware. Ceci peut corrompre l'image du firmware et causer un dysfonctionnement de l'unité.

ALERTE: N'utilisez que l'adaptateur d'alimentation fourni dans le pack GHP620/ GHP621. L'utilisation d'un autre adaptateur d'alimentation non qualifié peut endommager l'unité.

PRESENTATION:

La série GHP de téléphones d'hôtel comprend les GHP620(W) et GHP621(W), des téléphones IP faciles à utiliser pour toutes les chambres d'hôtel dont ils peuvent être programmés et personnalisés en fonction des besoins des hôtels et de leurs clients. Les modèles GHP620W et GHP621W sont équipés du Wi-Fi double bande intégré. Les fonctionnalités de la série GHP incluent un haut-parleur HD, 2 comptes/lignes SIP, 6 touches programmables, 10 touches de numérotation rapide, une conférence vocale à 3 voies, un codec audio Opus à bande complète et un algorithme avancé de résilience à la gigue qui tolère jusqu'à 30 % de perte de paquets sans affecter la qualité de la voix. La série GHP est prise en charge par Grandstream Device Management System (GDMS), qui fournit une interface centralisée pour configurer, provisionner, gérer et surveiller le déploiement des terminaux Grandstream. Les téléphones IP de la série GHP peuvent être installés sur un bureau ou fixés au mur et peuvent être alimentés par PoE et adaptateur secteur. Son design élégant et compact le rend parfait non seulement pour les hôtels, mais aussi pour les hôpitaux, les appartements, les dortoirs et bien plus encore.

CONTENU DU PAQUET:

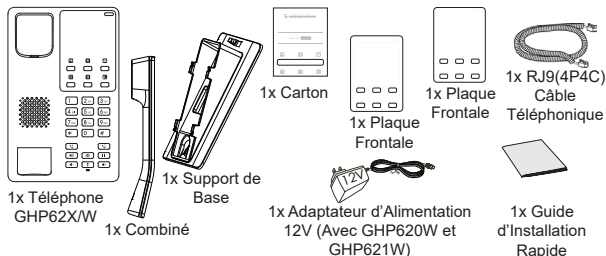

DESCRIPTION DU GHP620/W & GHP621/W

Panneau frontal

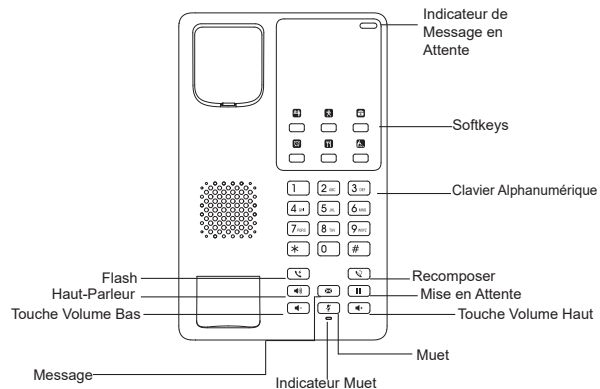

Note: La LED de l'indicateur de message en attente clignote en vert lorsqu'un message est en attente.

Panneau arrière

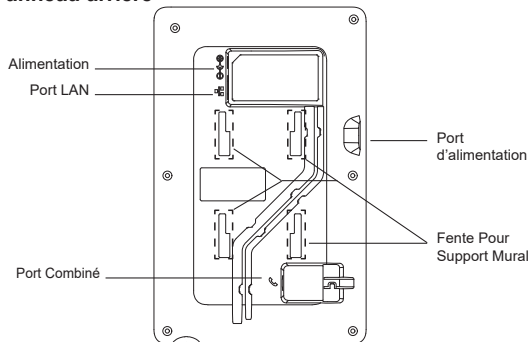

INSTALLATION DU TELEPHONE:

Fixation Murale

1. Marquez horizontalement deux points espacés de 100 mm entre lesquels sera monté le GHP620/W / GHP621/W.
2. À l'aide d'une perceuse, faites un trou sur chaque point marqué. Placez un boulon d'expansion en plastique et une vis (non fournie) sur chaque trou. Laissez suffisamment d'espace sur les vis pour monter le GHP620/W / GHP621/W.
3. Attachez le support de fixation murale à la fente située à l'arrière du téléphone.
4. Montez le GHP620/W / GHP621/W sur les vis à l'aide de ses "fentes pour montage murale".

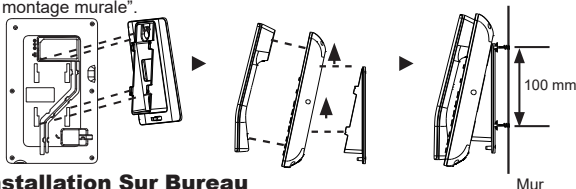

Installation Sur Bureau

Pour installer le téléphone sur la table avec le support du téléphone, attachez ce dernier à la fente placée à la base du téléphone.

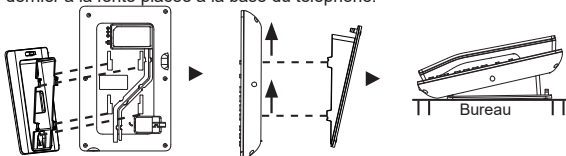

INSTALLATION DE LA PLAQUE FRONTALE:

1. Placez la carte papier personnalisée dans la rainure profonde de la coque de surface du téléphone et fixez-la.
2. Retirez le papier anti-adhésif de l'arrière de la plaque frontale.
3. Collez la plaque frontale sur la zone indiquée. Veuillez vous référer à l'illustration à droite.

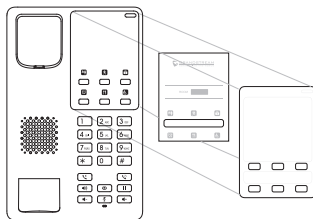

CONNECTER LE TELEPHONE:

Pour connecter le téléphone, veuillez suivre les étapes ci-dessous:

1. Connectez le combiné au téléphone en utilisant le câble téléphonique.
2. Connectez le port LAN de votre téléphone au port RJ-45 d'un concentrateur/commutateur ou un routeur (côté LAN du routeur) à l'aide du câble Ethernet. Ignorez cette étape si vous utilisez GHP620W/GHP621W.
3. Alimenter le téléphone:
 - **Option 1:** Connectez la fiche de sortie 12V DC à la prise d'alimentation sur le téléphone; branchez l'adaptateur dans une prise électrique.
 - **Option 2:** Un commutateur PoE doit être utilisé à l'étape 2.

Note: Pour un déploiement facile, le GHP620W/GHP621W est préconfiguré prêt à l'emploi pour se connecter à un SSID par défaut nommé **wp_master** avec un mot de passe (WPA / WPA2 PSK) égal à **wp!987@dmin**, les utilisateurs peuvent également adapter ces paramètres à partir de l'interface utilisateur Web, en afin de faciliter le déploiement sur le site client.

CONFIGURATION DU TELEPHONE:

1. Vérifiez que le téléphone est sous tension et connecté à Internet.
2. Localisez l'adresse MAC sur la balise MAC de l'unité, qui est sur la face arrière de l'appareil, ou sur le paquet.
3. Depuis un ordinateur connecté au même réseau que le GHP620/W / GHP621/W, tapez l'adresse suivante en utilisant l'adresse MAC du GHP620/W / GHP621/W dans votre navigateur **https://<mac>.local**

Exemple: <https://c074adfffff.local>

Note: L'utilisateur peut également composer ****47#** et l'adresse IP sera annoncée par l'IVR.

4. Entrez le nom d'utilisateur et le mot de passe d'administrateur pour accéder au menu de configuration. (Le nom d'utilisateur par défaut est "admin" tandis que le mot de passe peut être trouvé sur l'étiquette à l'arrière de l'unité).

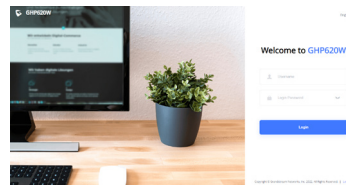

Télécharger le manuel d'utilisation et la FAQ pour plus de détails sur les instructions de configuration: <https://www.grandstream.com/our-products>

DE

Im GHP620/W / GHP621/W sind keine Notfallrufnummern voreingestellt oder vorkonfiguriert. Das GHP620/W / GHP621/W tätigt keine automatischen Anrufe zu medizinischen, sozialen oder juristischen Hilfs- oder Serviceorganisationen. Die Anbindung an derartige Einrichtungen muss separat eingestellt bzw. zur Verfügung gestellt werden. Es liegt in der Verantwortung des Nutzers, einen SIP-konformen Internet-Telefon-Service zu buchen, der die Nutzung der örtlichen und überregionalen Notrufnummern sicherstellt. Bietet der SIP-Anbieter diesen Service nicht, liegt es in der Verantwortung des Nutzers, einen analogen bzw. alternativen Telefonanschluss zusätzlich bereitzustellen, um eine telefonische Anbindung für Notfälle sicherstellen zu können.

GRANDSTREAM STELLT MIT DEM GHP620/W / GHP621/W KEINE VERBINDUNG ZU NOTFALLRUFNUMMER ODER DIE ANBINDUNG AN NOTFALLZENTREN ZUR VERFÜGUNG. WEDER GRANDSTREAM, NOCH GRANDSTREAM MITARBEITER, ANGESTELLTE ODER SONSTIGE FIRMEANGEHÖRIGE SIND FÜR DIE ANDBINDUNG DES GHP620/W / GHP621/W AN EINEN MEDIZINISCHEN SERVICE ODER ANDEREN NOTFALLDIENST ZUSTÄNDIG, BZW. VERANTWORTLICH. ES OBLIGT ALLEINIG IN DER VERANTWORTUNG DER GHP620/W / GHP621/W NUTZER BZW. DER GHP620/W / GHP621/W BESITZER, FÜR EINE NETZANBINDUNG ZU SORGEN, WELCHE DIE NUTZUNG VON MEDIZINISCHEN ODER ANDEREN NOTFALLRUFNUMMERN SICHERSTELLT.

Die GNU GPL Lizenz ist in der Gerätesoftware hinterlegt und kann über die Web-Schnittstelle unter [http\(s\)://IP/#/gpl_license](http(s)://IP/#/gpl_license).

Um eine CD mit der Lizenz zu erhalten, senden Sie uns bitte eine Email an info@Grandstream.com

VORSICHTSMAßNAHMEN:

ACHTUNG: Bitte unterbrechen Sie während des Systemstarts bzw. Während eines Software-Upgrades des GHP620/W / GHP621/W NICHT die Stromzufuhr. Eine Unterbrechung kann ein Fehlverhalten hervorrufen und das Telefon zerstören.

ACHTUNG: Benutzen Sie nur das Netzteil, das im Lieferumfang enthalten ist. Die Verwendung eines anderen Netzteils kann zu Schäden bzw. zum Defekt führen.

ÜBERBLICK:

Die GHP-Hotel-Telefon Serie, bestehend aus den Modellen GHP620 (W) und GHP621 (W), sind einfach zu bedienende, auf die Bedürfnisse von Hotelbetreiber und Gäste abgestimmte, IP-Telefone. Die Modelle GHP620W und GHP621W verfügen über eine integrierte Dualband-WLAN Schnittstelle, sowie einen HD-Lautsprecher, 2 SIP-Konten / -Leitungen, 6 programmierbare Tasten, 10 Kurzwahlkosten, 3-Wege-Sprachkonferenzen, Vollband-Opus-Sprach-Codex und einen leistungsstarken Jitter-Resilienz-Algorithmus, der bis zu 30% Paketverlust toleriert, ohne die Sprachqualität zu beeinträchtigen. Die GHP-Serie wird vom Grandstream Device Management System (GDMS) unterstützt, der zentralen Schnittstelle für Konfiguration, Provisionierung, Verwaltung und Überwachung von Grandstream Endgeräten. Die IP-Telefone der GHP-Serie können auf den Tisch gestellt oder an der Wand montiert werden und werden über PoE und ein Netzteil mit Strom versorgt. Durch das elegante und kompakte Design passt es hervorragend in Hotels aber auch in Krankenhäuser, Apartments, Schlafräume usw....

PACKUNGSINHALT:

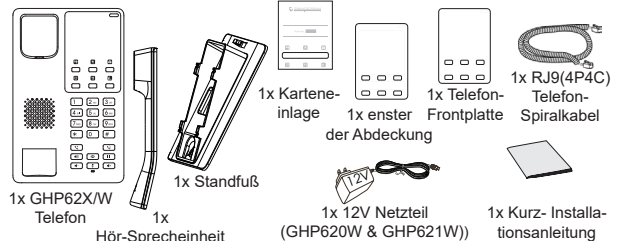

GHP620/W / GHP621/W BESCHREIBUNG:

Front-Platte

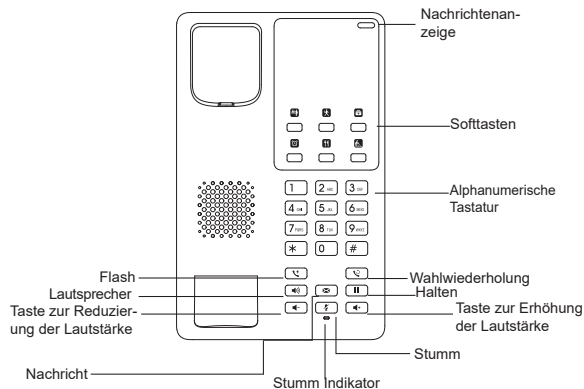

Hinweis: Der LED Indikator blinkt bei einer neuen Sprachnachricht grün.

Rückplatte

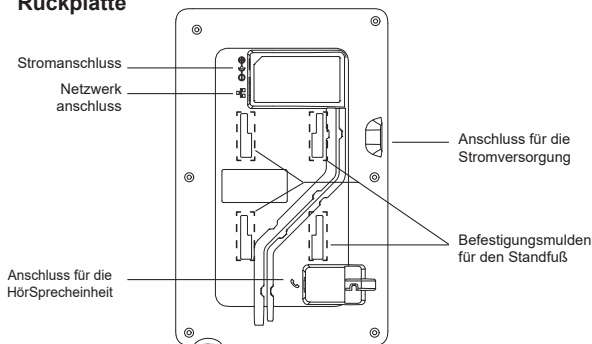

EINRICHTEN DES TELEFONS:

WANDMONTAGE

1. Markieren Sie an der vorgesehenen Wand zwei horizontale Löcher mit einem Abstand von 100 mm.
2. Bohren Sie nun zwei Löcher an den Markierungen in die Wand, beachten Sie hier die Durchmesser sowie die Länge der zu verwendenden Dübel und Schrauben. (Dübel & Schrauben sind nicht im Lieferumfang enthalten).
3. Führen Sie die Wandhalterung auf der Rückseite des Telefons in die dafür vorgesehenen Steckplätze ein.
4. vorgesehene Steckplätze ein.
5. Wandmontage der GHP62X/W.

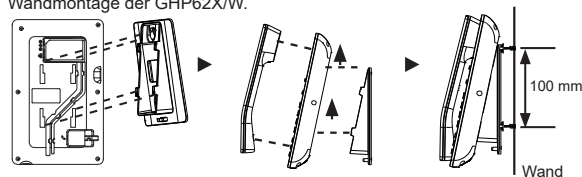

Tischmontage

Zur Nutzung des Telefons am Tisch, führen Sie bitte den mitgelieferten Standfuß in die auf der Rückseite des Telefons vorgesehene Montagesteckplätze ein.

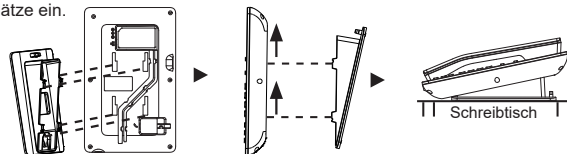

MONTAGE DER DISPLAYABDECKUNG

1. Legen Sie den individuellen Papiereinleger in die Vertiefung auf der Gerätegeeseite und fixieren Sie ihn.
2. Entfernen Sie die Schutzfolie der Displayabdeckung.
3. Stecken Sie die Displayabdeckung in den vorgegebenen Bereich. Bitte beachten Sie die nebenstehende Skizze.

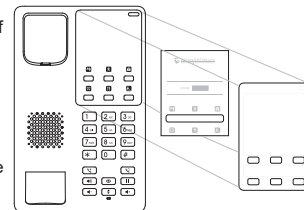

ANSCHLUSSMÖGLICHKEITEN AM TELEFON:

Um das Telefon einzurichten, gehen Sie bitte wie folgt vor:

1. Verbinden Sie den Hörer (RJ9 Port) und die Basis mit dem mitgelieferten Kabel.
2. Verbinden Sie den Netzwerk-Anschluss (RJ45) am Telefon mit dem dafür vorgesehenen Router / Switch, nutzen Sie hierfür das Netzkabel mit dem RJ45 Stecker. Wenn Sie ein GHP620W & GHP621W mit WLAN nutzen.
3. Stromversorgung des Telefons:
 - **Option 1:** Verbinden Sie das Netzteil mit dem Telefon und stecken dieses dann in die Steckdose.
 - **Option 2:** In Schritt 2 muss ein PoE Switch genutzt werden.

Anmerkungen: Um die Installation zu vereinfachen, hat das GHP620W/ GHP621W Wbereits eine SSID vorkonfiguriert, diese lautet **wp_master** und benötigt ein Passwort (WPA/ WPA2) gleich **wpi987@admin**. Diese Einstellungen können auch über die Weboberfläche adaptiert werden.

KONFIGURATION DES TELEFONS:

1. Stellen Sie sicher, dass das Telefon eingeschaltet ist und eine Internet-Verbindung besteht.
2. Die MAC Adresse des GHP620W/ GHP621W finden Sie auf der Unterseite des Gerätes oder auf der Aussenseite des Verpackungskartons.
3. Geben Sie nun in den Browser des im selben Netz befindlichen Computers folgende Information ein: **https://<mac>.local**

Beispiel: <https://c074adffff.local>

Anmerkungen: Durch wählen der ****47#** wird die IP Adresse über die IVR angesagt.

4. Geben Sie die die Anmeldeinformationen ein und wechseln Sie in das Konfigurationsmenü. (Herstellereitig ist der Benutzername "admin", das Zufallspasswort finden Sie auf der Rückseite der Basisstation)

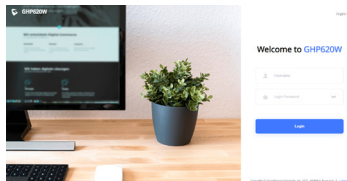

Weitere Informationen und Dokumentationen sind online unter: <https://www.grandstream.com/our-products>

IT

GHP620/W / GHP621/W non è preconfigurato per supportare o effettuare chiamate di emergenza a qualsiasi tipo di ospedale, struttura giudiziaria, unità di assistenza medica ("Servizi di emergenza") o a qualsiasi altro tipo di servizio di emergenza. È necessario effettuare accordi supplementari per ac emergenza. E' a Vostra esclusiva responsabilità acquistare servizi di telefonia internet conformi con SIP, configurare GHP620/W / GHP621/W correttamente per usare tale servizio ed effettuare test periodici della configurazione per assicurarsi che funzioni in modo idoneo. Se non si effettua ciò, è Vostra responsabilità acquistare servizi telefonici fissi o wireless tradizionali per accedere ai Servizi di emergenza.

GRANDSTREAM NON FORNISCE COLLEGAMENTI AI SERVIZI DI EMERGENZA ATTRAVERSO GHP620/W / GHP621/W. NÈ GRANSTREAM NÈ I SUOI RESPONSABILI, DIPENDENTI O AFFILIATI POSSONO ESSERE RITENUTI RESPONSABILI DI QUALSIASI RECLAMO, DANNO O PERDITA, E DI QUALSIASI AZIONE LEGALE DERIVANTE DA TALI RECLAMI O CAUSE IN RELAZIONE ALL'IMPOSSIBILITÀ DI USARE IL GHP620/W / GHP621/W PER CHIAMATE AI SERVIZI O DI STRINGERE ACCORDI SUPPLEMENTARI PER ACCEDERE AI SERVIZI DI EMERGENZA IN CONFORMITÀ AL PARAGRAFO PRECEDENTE.

I termini della licenza GNU GPL sono incorporati nel firmware del dispositivo e sono accessibili tramite l'interfaccia utente Web del dispositivo a: [http\(s\)://IP#/gpl_license](http(s)://IP#/gpl_license)
Per ottenere un CD con informazioni sul codice sorgente GPL, si prega di inviare una richiesta scritta a info@grandstream.com

PRECAUZIONI:

ATTENZIONE: NON spegnere/accendere il GHP620/W / GHP621/W durante l'avvio del sistema o l'aggiornamento del firmware. Ciò potrebbe comportare il danneggiamento del firmware e il malfunzionamento dell'unità.

ATTENZIONE: Usare solo l'alimentatore incluso nella confezione del GHP620/W / GHP621/W. L'uso di un alimentatore alternativo non idoneo potrebbe danneggiare l'unità.

PANORAMICA:

La serie di telefoni per hotel GHP comprende i modelli GHP620(W) e GHP621(W), telefoni IP di facile utilizzo per qualsiasi camera d'albergo che possono essere programmati e personalizzati in base alle esigenze degli hotel e dei loro ospiti. I modelli GHP620W e GHP621W sono dotati di Wi-Fi dual-band integrato. Le caratteristiche della serie GHP includono altoparlante HD, 2 account/linee SIP, 6 tasti programmabili, 10 tasti di selezione rapida, audio conferenza a 3, codec vocale Opus a banda intera e algoritmo avanzato di resilienza al jitter che tollera fino al 30% di perdita di pacchetti senza impattare sulla qualità della voce. La serie GHP è supportata dal Device Management System di Grandstream (GDMS), che fornisce un'interfaccia centralizzata per la configurazione, il provisioning, la gestione e il monitoraggio della distribuzione degli endpoint di Grandstream. I telefoni IP della serie GHP possono essere installati su scrivania o a parete e possono essere alimentati tramite PoE e alimentatore. Il design elegante e compatto lo rende perfetto non solo per gli hotel, ma anche per ospedali, appartamenti, dormitori e molte altre strutture.

CONTENUTO DELLA CONFEZIONE:

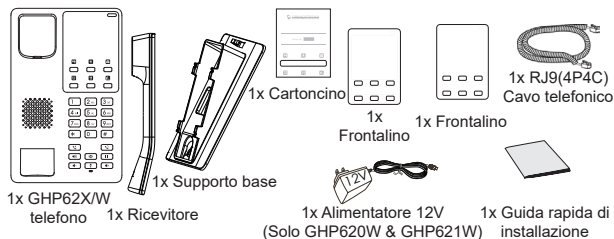

GHP620/W & GHP621/W DESCRIZIONE:

Pannello anteriore

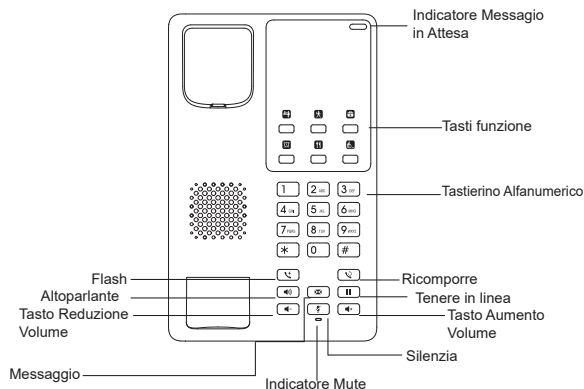

Note: Il LED dell'indicatore di messaggi in attesa lampeggia di colore verde quando è presente un messaggio in attesa.

Pannello posteriore

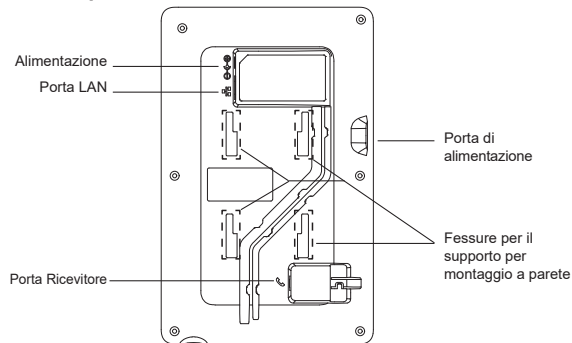

MONTAGGIO TELEFONO:

Montaggio a Parete:

1. Contrassegnare due punti orizzontalmente con 100 mm tra loro dove porre il supporto a parete GHP620/W / GHP621/W.
2. Usando un trapano, effettuare un foro per ogni punto contrassegnato. Porre un perno di espansione di plastica e la vite (non fornita) su ogni foro. Lasciare abbastanza spazio sulle viti per montare GHP620/W / GHP621/W.
3. Fissare i distanziali per il supporto a parete nell'apposito alloggiamento sul retro del telefono.
4. Montare il GHP620/W / GHP621/W sulle viti usando le sue "Scanalature del supporto a parete".

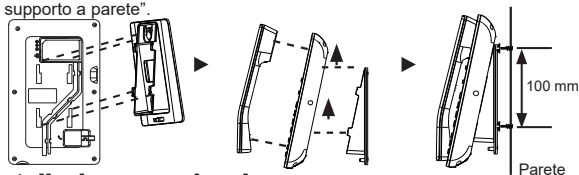

Installazione a scrivania

Per installare il telefono sul tavolo con il supporto telefono, fissare il supporto alla base del telefono dove si trova un alloggiamento per tale supporto. (metà superiore, parte inferiore).

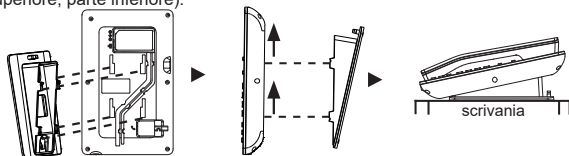

INSTALLAZIONE DEL FRONTALINO:

1. Inserire il cartoncino personalizzato nella scanalatura sulla superficie del telefono e fissarlo.
2. Rimuovere la pellicola protettiva dal retro dell'etichetta del frontalino
3. Incollare il frontalino nell'area indicata. Fare riferimento all'illustrazione a destra.

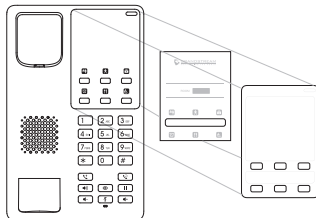

CONNESSIONE DEL TELEFONO:

Per configurare il telefono, seguire la seguente procedura:

1. Collegare il ricevitore (porta RJ9) e la base mediante il cavo telefonico.
2. Collegare la porta LAN del telefono alla presa RJ-45 di un hub o di un router (lato LAN del router) usando un cavo ethernet. Questo passo deve essere saltato, Se è utilizzato GHP620W & GHP621W with Wi-Fi.
3. Come alimentare il telefono:
 - **Opzione 1:** Collegare il jack dell'alimentatore all'uscita 12V CC sul telefono; collegare l'alimentatore a una presa elettrica.
 - **Opzione 2:** al punto 2 è necessario utilizzare uno switch PoE.

Nota: Per facilitare l'installazione, il GHP620W/GHP621W è preconfigurato di fabbrica per connettersi a tutti i SSID con nome **wp_master** e con password (WPA/ WPA2 PSK) uguale a **wp!987@admin**, gli utenti possono modificare queste impostazioni anche dalla web UI, così da facilitare l'installazione dal cliente.

CONFIGURAZIONE DEL TELEFONO:

1. Assicurarsi che il telefono sia in corrente e collegato a internet.
2. Individuare il MAC address sull'etichetta posizionata nella parte bassa dell'apparato o sulla confezione.
3. Da un computer collegato alla stessa rete del GHP620/W / GHP621/W, digitare il seguente indirizzo usando l'indirizzo MAC del GHP620/W / GHP621/W sul proprio browser: **https://<mac>.local**

Esempio: <https://c074adffff.local>

Nota: L'utente può anche comporre ****47#** e l'indirizzo IP verrà letto dall'IVR.

4. Immettere il nome utente e la password dell'amministratore per accedere al menu di configurazione. (Il nome utente predefinito di fabbrica è "admin" mentre la password casuale predefinita può essere trovata sull'adesivo sul retro dell'unità).

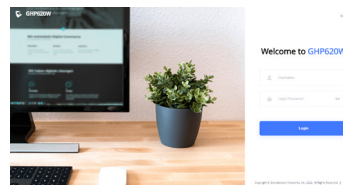

Fare riferimento ai documenti online e alle Domande Frequenti per informazioni più dettagliate: <https://www.grandstream.com/our-products>

GHP620/W / GHP621/W предварительно не сконфигурирован для поддержки или переноса экстренных звонков в какие-либо больницы, правоохранительные органы, отделения медицинской помощи ("Экстренная (-ые) Служба (-ы)"), или какие-либо другие Экстренные службы. Следует произвести дополнительные настройки для доступа к Экстренным Службам. Вы ответственны за подключение SIP-совместимой интернет-телефонной службы, правильную настройку GHP620/W / GHP621/W для ее использования, а также периодическое тестирование Вашей конфигурации для проверки ее работы в соответствии с Вашими требованиями. Если Вы это не сделаете, Вы будете ответственны за подключение традиционных беспроводных или проводных телефонных служб для доступа к Экстренным Службам

GRANDSTREAM НЕ ПРЕДОСТАВЛЯЕТ СОЕДИНЕНИЯ С ЭКСТРЕННЫМИ СЛУЖБАМИ ПОСРЕДСТВОМ GHP620/W / GHP621/W. GRANDSTREAM, ЕГО СЛУЖАЩИЕ, РАБОТНИКИ И ОТДЕЛЕНИЯ НЕ НЕСУТ ОТВЕТСТВЕННОСТИ ЗА ПРЕТЕНЗИИ, УЩЕРБ ИЛИ УТРАТУ, И ВЫ НАСТОЯЩИМ ОТКАЗЫВАЕТЕСЬ ОТ КАКИХ-ЛИБО ЗАЯВЛЕНИЙ ИЛИ ИСКОВЫХ ОСНОВАНИЙ, ПРОИСТЕКАЮЩИХ ИЗ ВАШЕЙ НЕСПОСОБНОСТИ ИСПОЛЬЗОВАТЬ GHP620/W / GHP621/W ДЛЯ СВЯЗИ С ЭКСТРЕННЫМИ СЛУЖБАМИ И НЕПРИНЯТИЯ С ВАШЕЙ СТОРОНЫ МЕР ПО ОБЕСПЕЧЕНИЮ ДОСТУПА К ЭКСТРЕННЫМ СЛУЖБАМ В СООТВЕТСТВИИ С ВЫШЕСЛЕДУЮЩИМ ПАРАГРАФОМ.

Условия лицензии GNU GPL включены в прошивку устройства и доступны через веб-интерфейс пользователя устройства по адресу [http\(s\)://IP#/gpl_license](http(s)://IP#/gpl_license). Для получения компакт-диска с информацией об исходном коде GPL, пожалуйста, отправьте письменный запрос по адресу info@grandstream.com

МЕРЫ ПРЕДОСТОРОЖНОСТИ:

ВНИМАНИЕ: Пожалуйста, не перезагружайте GHP620/W / GHP621/W путем выключения питания во время начальной загрузки системы или обновления встроенной программы. Вы можете повредить образы встроенной программы и вызвать неправильную работу устройства.

ВНИМАНИЕ: Используйте только блок питания, входящий в комплект поставки GHP620/W / GHP621/W. Использование неподходящего блока питания может вызвать повреждение устройства.

ОБЗОР:

Серия гостиничных телефонов GHP включает GHP620(W) и GHP621(W), простые в использовании IP-телефоны для любых гостиничных номеров, которые можно запрограммировать и настроить в соответствии с требованиями отелей и их гостей. Модели GHP620W и GHP621W оснащены встроенным двухдиапазонным Wi-Fi модулем. Набор функций серии GHP включает HD-динамик, 2 учетные записи/линии SIP, 6 программируемых клавиш, 10 клавиш быстрого набора, трехстороннюю голосовую конференцию, полнодиапазонный голосовой кодек Opus и усовершенствованный алгоритм устойчивости к джиттеру, который допускает потерю пакетов до 30% без ущерба для качества голоса. Серия GHP поддерживается системой управления устройствами Grandstream (GDMS), которая обеспечивает централизованный интерфейс для настройки, управления и мониторинга развертывания терминалов Grandstream. IP-телефоны серии GHP могут устанавливаться на столе или на стене и питаться от PoE и адаптера питания. Благодаря элегантному и компактному дизайну он идеально подходит не только для гостиниц, но и для больниц, квартир, общежитий и многого другого.

КОМПЛЕКТ ПСТАВКИ:



ОПИСАНИЕ ТЕЛЕФОНА:

Передняя панель



Примечание: При наличии ожидающего сообщения светодиод индикатора ожидающего сообщения будет мигать зеленым цветом.

УСТАНОВКА ЛИЦЕВОЙ ПАНЕЛИ

1. Поместите индивидуальную бумажную карточку в канавку корпуса телефона и закрепите ее.
2. Снимите защитную бумагу с задней части лицевой панели.
3. Наклейте лицевую панель на указанную область. Смотрите иллюстрацию справа.

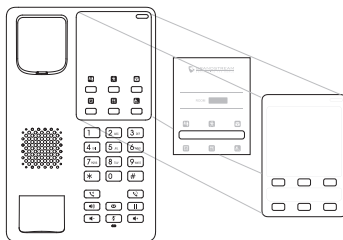

Смотрите электронные документы и раздел FAQ для более подробной информации: <https://www.grandstream.com/our-products>

PT

O GHP620/W / GHP621/W não é préconfigurado para suportar ou realizar chamadas de emergência a qualquer tipo de hospital, agência policial, unidade de atendimento médico (“Serviço (s) de emergência”), ou qualquer outro tipo de serviço de emergência. Você deverá tomar providências adicionais para acessar serviços de emergência. É da sua responsabilidade adquirir serviço de telefonia via Internet compatível com o protocolo SIP, configurar corretamente o GHP620/W / GHP621/W para usar esse serviço e periodicamente testar a configuração para confirmar que ele funciona como você espera. Se você não fizer isso, é da sua responsabilidade adquirir os serviços tradicionais de telefones celulares ou fixos para acessar serviços de emergência.

GRANDSTREAM NÃO FORNECE CONEXÕES A SERVIÇOS DE EMERGÊNCIA ATRAVÉS DO GHP620/W / GHP621/W. NEM GRANDSTREAM, NEM OS SEUS DIRIGENTES, EMPREGADOS OU AFILIADOS PODEM SER RESPONSABILIZADOS POR QUALQUER RECLAMAÇÃO, DANO OU PERDA, E VOCÊ, NESTE ATO, RENUNCIA QUAISQUER E TODAS REIVINDICAÇÕES OU MOTIVOS DE ACÇÃO RESULTANTES DA OU RELATIVA À SUA INCAPACIDADE DE USAR O GHP620/W / GHP621/W PARA CONTATAR SERVIÇOS DE EMERGÊNCIA E POR NÃO FAZER ARRANJOS ADICIONAIS PARA ACEDER AOS SERVIÇOS DE EMERGÊNCIA, SEGUNDO O PARÁGRAFO IMEDIATAMENTE ANTERIOR.

Os termos de licença GNU GPL estão dentro do firmware do dispositivo e você pode visualizar o documento através da interface web do dispositivo, em [http\(s\)://IP/#/gpl_license](http(s)://IP/#/gpl_license).

Para obter um CD com a informação do código fonte GPL, por favor solicite-o através de info@grandstream.com

PRECAUÇÕES:

ATENÇÃO: Por favor NÃO desligue a energia do GHP620/W / GHP621/W durante o início do sistema ou durante a atualização de firmware. Você poderá corromper a imagem do firmware e originar o mau funcionamento da unidade.

ATENÇÃO: Utilize unicamente a fonte de alimentação incluída na embalagem do GHP620/W / GHP621/W. Utilizar uma fonte de alimentação alternativa e não certificada possivelmente pode danificar a unidade.

RESUMO:

A série GHP de telefones para hotéis apresenta o GHP620(W) e GHP621(W), telefones IP fáceis de usar para qualquer quarto de hotel que podem ser programados e personalizados com base nas necessidades dos hotéis e seus hóspedes. Os modelos GHP620W e GHP621W estão equipados com Wi-Fi de banda dupla integrado. Os recursos da série GHP incluem alto-falante HD, 2 contas/linhas SIP, 6 teclas programáveis, 10 teclas de discagem rápida, conferência de voz de 3 vias, codec de voz Opus e algoritmo avançado de jitter que tolera até 30% de perda de pacotes sem afetar a qualidade da voz. A série GHP é suportada pela plataforma Grandstream Device Management System (GDMS), que fornece uma interface centralizada para configurar, provisionar, gerenciar e monitorar a implantação de terminais IP da Grandstream. Os telefones IP da série GHP podem ser instalados na mesa/escritório ou montados na parede e podem ser alimentados por PoE e adaptador de energia. Seu desenho elegante e compacto o torna perfeito não apenas para hotéis, mas também para hospitais, apartamentos, dormitórios e muito mais.

CONTEÚDO DA EMBALAGEM:

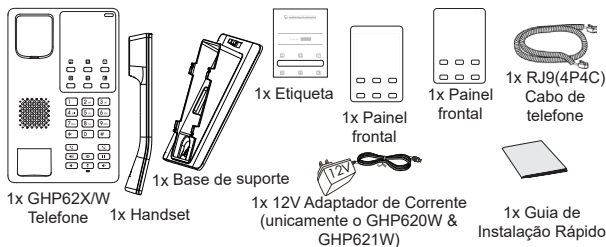

DESCRIÇÃO DO TELEFONE:

Painel Frontal

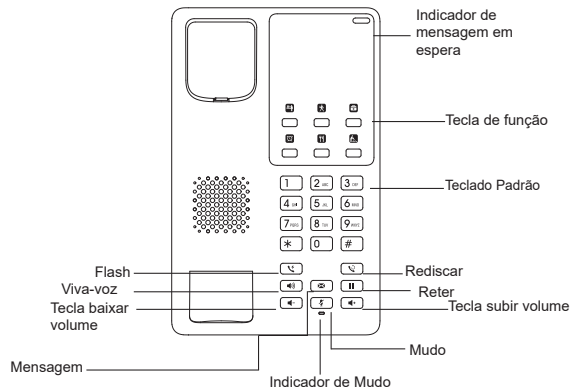

Aviso: O LED do indicador de mensagem em espera piscará na cor verde quando houver uma mensagem em espera.

Painel posterior

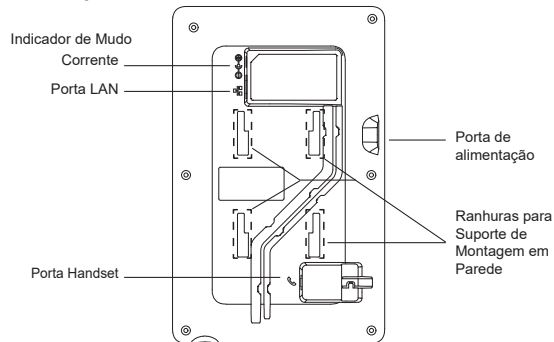

Instalação do Telefone: Montagem na Parede

1. Marque dois pontos de maneira horizontal com separação de 100 mm entre eles onde será colocada a GHP620/W / GHP621/W.
2. Utilizando uma broca, faça um buraco em cada ponto marcado. Coloque um parafuso de expansão de plástico e um parafuso (não incluídos) em cada furo. Deixe espaço suficiente nos parafusos para a montagem da GHP620/W / GHP621/W.
3. Coloque o suporte de parede na abertura que está na parte traseira do telefone.
4. Coloque a GHP620/W / GHP621/W nos parafusos utilizando as "Ranuras de montagem na parede".

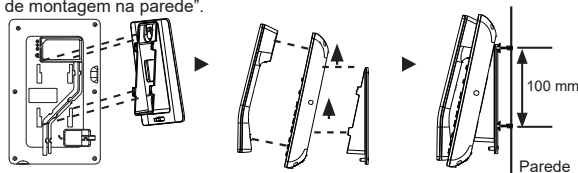

Instalação em escritório

Para instalar o telefone no escritório com o suporte do telefone, fixe o suporte no fundo do telefone onde estão as aberturas para o suporte de escritório (parte de cima, parte do fundo)

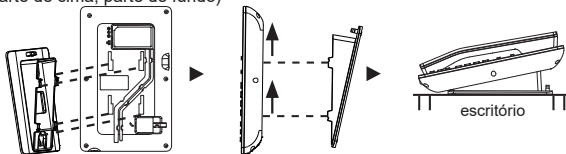

INSTALAÇÃO DO PAINEL FRONTAL:

1. Coloque a etiqueta personalizada na ranhura profunda na superfície do painel superior do telefone e fixe-o.
2. Remova o papel de liberação da parte de trás do painel frontal.
3. Cole o painel frontal na área indicada. Consulte a ilustração à direita.

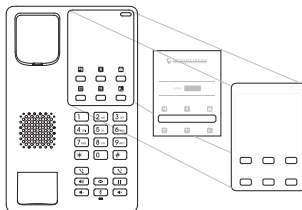

A CONECTAR O TELEFONE:

Para configurar o telefone, siga o procedimento indicado abaixo:

1. Conecte o monofone/handset (porta RJ9) e a base com o cabo telefônico.
2. Conecte a porta LAN do telefone à tomada RJ-45 de um hub/switch ou um roteador (lado de LAN do roteador) utilizando o cabo de Ethernet. Se GHP620W / GHP621W é utilizado, esta configuração pode ser desconsiderada.
3. Ligando o telefone:
 - **Opção 1:** Conecte a saída da fonte de alimentação 12V DC na porta correspondente no telefone; conecte a fonte de alimentação em uma tomada de energia.
 - **Opção 2:** Um switch PoE deve ser usado no passo 2.

Aviso: Para fácil implantação, o GHP620W/GHP621W vem pre-configurado para se conectar a um SSID padrão chamado **wp_master** com uma senha (WPA / WPA2 PSK) igual a **wp!987@admin**, os usuários podem adaptar essas configurações da interface web também para facilitar a implantação no local do cliente.

CONFIGURAÇÃO DO TELEFONE:

1. Verifique e confira que o telefone está ligado e conectado à internet.
2. Localize o endereço MAC na etiqueta da unidade, que está na parte inferior do dispositivo ou na caixa.
3. A partir de um computador conectado à mesma rede do GHP620/W / GHP621/W, coloque o endereço MAC do GHP620/W / GHP621/W no navegador da seguinte maneira: **https://<mac>.local**

Exemplo: <https://c074adfffff.local>

Aviso: O usuário também pode discar ****47#** e o endereço IP será lido pelo IVR

4. Coloque o ID e a senha do administrador para acessar o menu de configuração. (O ID de usuário padrão é "admin", a senha de acesso aleatória pode ser encontrada na etiqueta na parte inferior do dispositivo).

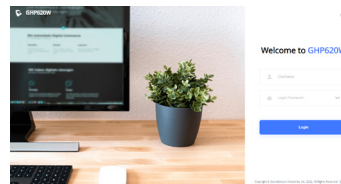

Consulte os documentos em linha e os FAQ para informação mais detalhada: <https://www.grandstream.com/our-products>

Certification Regulatory Information:

For GHP62x

1. U.S. FCC Part 68 Regulatory Information

This equipment complies with Part 68 of the FCC rules. Located on the equipment is a label that contains, among other information, the ACTA registration number and ringer equivalence number (REN.) If requested, this information must be provided to the telephone company.

The REN is used to determine the quantity of devices which may be connected to the telephone line. Excessive REN's on the telephone line may result in the devices not ringing in response to an incoming call. In most, but not all areas, the sum of the REN's should not exceed five (5.0). To be certain of the number of devices that may be connected to the line, as determined by the total REN's contact the telephone company to determine the maximum REN for the calling area.

This equipment cannot be used on the telephone company-provided coin service. Connection to Party Line Service is subject to State Tariffs.

If this equipment causes harm to the telephone network, the telephone company will notify you in advance that temporary discontinuance of service may be required. If advance notice isn't practical, the telephone company will notify the customer as soon as possible. Also, you will be advised of your right to file a complaint with the FCC if you believe it is necessary. The telephone company may make changes in its facilities, equipment, operations, or procedures that could affect the operation of the equipment. If this happens, the telephone company will provide advance notice in order for you to make the necessary modifications in order to maintain uninterrupted service.

If the trouble is causing harm to the telephone network, the telephone company may request you to remove the equipment from the network until the problem is resolved. This equipment uses the following USOC jacks: RJ45C. It is recommended that the customer install an AC surge arrester in the AC outlet to which this device is connected. This is to avoid damaging the equipment caused by local lightning strikes and other electrical surges.

If trouble is experienced with this equipment, please contact (Agent in the US):

Company Name: Grandstream Networks, Inc.

Address: 126 Brookline Ave, 3rd Floor Boston, MA 02215, USA

Tel: 1-617-5669300

Fax: 1-617-2491987

2. U.S. FCC Part 15 Regulatory Information

This device complies with part 15 of the FCC Rules. Operation is subject to the following two conditions:(1) this device may not cause harmful interference, and(2) this device must accept any interference received, including interference that may cause undesired operation.

Any Changes or modifications not expressly approved by the party responsible for compliance could void the user's authority to operate the equipment.

Note: This equipment has been tested and found to comply with the limits for a Class B digital device, pursuant to part 15 of the FCC Rules. These limits are designed to provide reasonable protection against harmful interference in a residential installation. This equipment generates, uses and can radiate radio frequency energy and, if not installed and

used in accordance with the instructions, may cause harmful interference to radio communications. However, there is no guarantee that interference will not occur in a particular installation. If this equipment does cause harmful interference to radio or television reception, which can be determined by turning the equipment off and on, the user is encouraged to try to correct the interference by one or more of the following measures:

—Reorient or relocate the receiving antenna.

—Increase the separation between the equipment and receiver.

—Connect the equipment into an outlet on a circuit different from that to which the receiver is connected.

—Consult the dealer or an experienced radio/TV technician for help.

3. Canada Regulatory Information

This product meets the applicable Innovation, Science and Economic Development Canada technical specifications.

The Ringer Equivalence Number (REN) indicates the maximum number of devices allowed to be connected to a telephone interface. The termination of an interface may consist of any combination of devices subject only to the requirement that the sum of the RENs of all the devices not exceed five.

Ce produit répond à la innovation, des sciences et de Développement économique Canada spécifications techniques applicables.

Le nombre équivalent de sonneries (REN) indique le nombre maximal de terminaux qui peuvent être raccordés à une interface téléphonique. La terminaison d'une interface peut consister en un combinaison de dispositifs, à la seule condition que la somme des REN de tous les dispositifs ne dépasse pas cinq.

4. EU Regulatory Information

Hereby, [Grandstream Networks, Inc.] declares that the radio equipment type [GHP621/GHP620] is in compliance with Directive 2014/30/EU.

The full text of the EU declaration of conformity is available at the following internet address: www.grandstream.com

5. UK Regulatory Information

Hereby, [Grandstream Networks, Inc.] declares that the radio equipment type [GHP621/GHP620] is in compliance with UK SI 2016 No. 1091

The full text of the UK declaration of conformity is available at the following internet address: www.grandstream.com

For GHP62xW

Common part

This equipment complies with radiation exposure limits set forth for an uncontrolled environment. This transmitter must not be co-located or operating in conjunction with any other antenna or transmitter.

Après examen de ce matériel aux conformités ou aux limites d'intensité de champ RF, les utilisateurs peuvent sur l'exposition aux radiofréquences et la conformité and compliance d'acquérir les informations correspondantes.

This equipment should be installed and operated with minimum distance 20cm between the radiator& your body.

La distance minimale du corps à utiliser le dispositif est de 20cm.

1. U.S. FCC Part 68 Regulatory Information

This equipment complies with Part 68 of the FCC rules. Located on the equipment is a label that contains, among other information, the ACTA registration number and ringer equivalence number (REN.) If requested, this information must be provided to the telephone company.

The REN is used to determine the quantity of devices which may be connected to the telephone line. Excessive REN's on the telephone line may result in the devices not ringing in response to an incoming call. In most, but not all areas, the sum of the REN's should not exceed five (5.0). To be certain of the number of devices that may be connected to the line, as determined by the total REN's contact the telephone company to determine the maximum REN for the calling area.

This equipment cannot be used on the telephone company-provided coin service. Connection to Party Line Service is subject to State Tariffs.

If this equipment causes harm to the telephone network, the telephone company will notify you in advance that temporary discontinuance of service may be required. If advance notice isn't practical, the telephone company will notify the customer as soon as possible. Also, you will be advised of your right the file a complaint with the FCC if you believe it is necessary. The telephone company may make changes in its facilities, equipment, operations, or procedures that could affect the operation of the equipment. If this happens, the telephone company will provide advance notice in order for you to make the necessary modifications in order to maintain uninterrupted service.

If the trouble is causing harm to the telephone network, the telephone company may request you to remove the equipment from the network until the problem is resolved.

This equipment uses the following USOC jacks: RJ45C.

It is recommended that the customer install an AC surge arrester in the AC outlet to which this device is connected. This is to avoid damaging the equipment caused by local lightning strikes and other electrical surges.

The earpiece is easy to absorb small object, please take care to avoid scratching.

If trouble is experienced with this equipment, please contact (Agent in the US):

Company Name: Grandstream Networks, Inc.

Address: 126 Brookline Ave, 3rd Floor Boston, MA 02215, USA

Tel: 1-617-5669300

2. U.S. FCC Part 15 Regulatory Information

This device complies with part 15 of the FCC Rules. Operation is subject to the following two conditions: (1) this device may not cause harmful interference, and (2) this device must accept any interference received, including interference that may cause undesired operation.

Any Changes or modifications not expressly approved by the party responsible for compliance could void the user's authority to operate the equipment.

Note: This equipment has been tested and found to comply with the limits for a Class B digital device, pursuant to part 15 of the FCC Rules. These limits are designed to provide reasonable protection against harmful interference in a residential installation. This equipment generates, uses and can radiate radio frequency energy and, if not installed and used in accordance with the instructions, may cause harmful interference to radio communications. However, there is no guarantee that interference will not occur in a particular installation. If this equipment does cause harmful interference to radio or television reception,

which can be determined by turning the equipment off and on, the user is encouraged to try to correct the interference by one or more of the following measures:

—Reorient or relocate the receiving antenna.

—Increase the separation between the equipment and receiver.

—Connect the equipment into an outlet on a circuit different from that to which the receiver is connected.

—Consult the dealer or an experienced radio/TV technician for help.

3. Canada Regulatory Information

Radio equipment

Operation of 5150-5350 MHz is restricted to indoor use only.

This device contains licence-exempt transmitter(s)/receiver(s) that comply with Innovation, Science and Economic Development Canada's licence-exempt RSS(s). Operation is subject to the following two conditions:

(1) This device may not cause interference.

(2) This device must accept any interference, including interference that may cause undesired operation of the device.

L'émetteur/récepteur exempt de licence contenu dans le présent appareil est conforme aux CNR d'Innovation, Sciences et Développement économique Canada applicables aux appareils radio exempts de licence. L'exploitation est autorisée aux deux conditions suivantes :

1) L'appareil ne doit pas produire de brouillage;

2) L'appareil doit accepter tout brouillage radioélectrique subi, même si le brouillage est susceptible d'en compromettre le fonctionnement.

CAN ICES-003 (B)/NMB-003(B)

This product meets the applicable Innovation, Science and Economic Development Canada technical specifications.

Le présent produit est conforme aux spécifications techniques applicables d'Innovation, Sciences et Développement économique Canada.

Terminal equipment

This product meets the applicable Innovation, Science and Economic Development Canada technical specifications.

The Ringer Equivalence Number (REN) indicates the maximum number of devices allowed to be connected to a telephone interface. The termination of an interface may consist of any combination of devices subject only to the requirement that the sum of the RENs of all the devices not exceed five.

Ce produit répond à la innovation, des sciences et de Développement économique Canada spécifications techniques applicables.

Le nombre équivalent de sonneries (REN) indique le nombre maximal de terminaux qui peuvent être raccordés à une interface téléphonique. La terminaison d'une interface peut consister en une combinaison de dispositifs, à la seule condition que la somme des REN de tous les dispositifs ne dépasse pas cinq.

4. EU Regulatory Information

In all EU member states, operation of 5150-5350 MHz is restricted to indoor use only. Support Frequency Bands and Power:

WLAN 2412-2472 MHz < 20 dBm;
RLAN 5150-5250 MHz < 23 dBm;
RLAN 5250-5350 MHz < 20 dBm;
RLAN 5470-5725 MHz < 20 dBm;
RLAN 5745-5825 MHz < 14 dBm.

The simplified EU declaration of conformity referred to in Article 10(9) shall be provided as follows:

Hereby, [Grandstream Networks, Inc.] declares that the radio equipment type [GHP621W, GHP620W] is in compliance with Directive 2014/53/EU.

The full text of the EU declaration of conformity is available at the following internet address:
www.grandstream.com